

The art of packaging™



YESPAC

Paper Hot Cups

Letter From The CEO	04
About us	05
Products	07
Capabilities	09
Operational Impact	10
Green Initiative	11
Industries	13
Custom Designs	14

Paper Hot Cups **15**

4oz Paper Single Wall Hot Cups	16
6oz Paper Single Wall Hot Cup	17
8oz Paper Single Wall Hot Cup	18
10oz Squat Single Wall Paper Hot Cups	19
12oz Paper Single Wall Hot Cup	20
16oz Paper Single Wall Hot Cup	21
20oz Paper Single Wall Hot Cup	22
24oz Paper Single Wall Hot Cup	23

Double Wall Paper Hot Cup **24**

4oz Double Wall Paper Hot Cup	25
6oz Double Wall Paper Hot Cup	26
8oz Double Wall Paper Hot Cup	27
10oz Double Wall Paper Hot Cup	28
12oz Double Wall Paper Hot Cup	29
16oz Double Wall Paper Hot Cup	30
20oz Double Wall Paper Hot Cup	31

Kraft Paper Double Wall Hot Cups **32**

8oz Kraft Stock Double Wall Hot Cup	33
10oz Kraft Stock Double Wall Hot Cup	34
12oz Kraft Stock Double Wall Hot Cup	35
16oz Kraft Stock Double Wall Hot Cup	36
20oz Kraft Stock Double Wall Hot Cup	37

Double Wall Paper Hot Cup **38**

4oz Double Wall Paper Hot Cup	39
6oz Double Wall Paper Hot Cup	40
8oz Double Wall Paper Hot Cup	41
10oz Double Wall Paper Hot Cup	42
12oz Double Wall Paper Hot Cup	43
20oz Double Wall Paper Hot Cup	44

Paper Cold Cups **45**

4.5oz Cone Water Cups-Rolled Rim	46
4oz Single Wall Paper Cold Cup	47
6oz Single Wall Paper Cold Cup	48
8oz Single Wall Paper Cold Cup	49
10oz Single Wall Paper Cold Cup	50
12oz Single Wall Paper Cold Cup	51
14oz Single Wall Paper Cold Cup	52
16oz Single Wall Paper Cold Cup	53
20oz Single Wall Paper Cold Cup	54
21oz Single Wall Paper Cold Cup	55
22oz Single Wall Paper Cold Cup	56
24oz Single Wall Paper Cold Cup	57
32oz Single Wall Paper Cold Cup	58

Cup Lids **59**

Polystyrene Hot Cup Dome Lids fits 4oz	60
Polystyrene Hot Cup Dome Lids fits 6oz	61
Polystyrene Hot Cup Dome Lids fits 8oz	62
Polystyrene Hot Cup Dome Lids fits 10oz - 24oz	63
Clear PET Cold Cup Flat Straw Slot Lids fits 12oz - 24oz	64
Clear PET Dome Lids for Paper Cold Cups fits 8/9oz	65
Clear PET Flat Lids for Paper Cold Cups fits 8/9oz	66

PET Cups & Lids **67**

12oz PET Clear Plastic Cold Cups	68
16oz PET Clear Plastic Cold Cups	69
Cold Cup Flat Straw Slot Lids fits 12oz - 24oz PET	70

Plastic Containers **71**

18oz Salad Bowl	72
24oz Salad Bowl	73
32oz Salad Bowl	74
48oz Salad Bowl	75
24oz Salad Bowl Bulk (Bowl Only)	76
32oz Salad Bowl Bulk (Bowl Only)	77

Clamshell Containers **78**

6" x 6" x 3" Clamshell	79
6"x6"x3 3/8" Clamshell	80
8"x8"x2 3/4" Clamshell	81
8"x8"x3 3/8" Clamshell	82
8"x8"x3 3/8" 3 Compartment Clamshell	83
9"x9"x3" Clamshell	84
9"x9"x3" 3 Compartment Clamshell	85
9"x9"x3 1/2" Clamshell	86
9 3/10" x 5 1/2" x 3 1/3" Smooth Wall Hinge Container	87
9 3/8" x 6 3/4" x 2 3/16" Smooth Wall Hinge Container	88
9 3/10" x 5 1/2" x 3 1/3" Smooth Wall Hinge Container	89
6"x6"x3" Smooth Wall Clamshell	90
6"x6"x3 3/8" Smooth Wall Clamshell	91

Deli Containers **92**

24 oz Oblong Deli Container Only	93
24oz Oblong Deli Container with Dome Lid	94
24oz Oblong Deli Container with Flat Lid	95
32 oz Oblong Deli Container Only	96
32oz Oblong Deli Container with Dome Lid	97
32 oz Oblong Deli Container Only	98
32oz Oblong Deli Container with Flat Lid	99
Flat Lids for 24 & 32oz Oblong Deli Container	100
Dome Lids for 24 & 32oz Oblong Deli Container	101

Paper Food Containers **102**

8oz Paper Food Container Bulk (No Lid)	103
12oz Paper Food Container Bulk (No Lid)	104
16oz Squat Paper Food Container	105
16oz Tall Paper Food Container Bulk (No Lid)	106
32oz Paper Food Container	107
Plastic Lids for 8oz - 16oz Tall Paper Food Containers	108
Paper Vented Lids for 8oz-16oz Tall Paper Food Containers	109
Paper Vented Lids for 8oz-16oz Tall Paper Food Containers	110
Paper Vented Lids for 16oz Squat & 32oz Paper Food Containers	111
8oz Paper Food Container Combo w/Paper Vented Lid	112
12oz Paper Food Container Combo w/ Paper Vented Lid	113
16oz Tall Paper Food Container Combo w/Paper Vented Lid	114
16oz Squat Paper Food Container Combo w/Paper Vented Lid	115
32oz Paper Food Container Combo w/Paper Vented Lid	116
32oz Paper Food Container Combo w/Paper Vented Lid	117
8oz Paper Food Container Combo w/Plastic PP Vented Lid	118
12oz Paper Food Container Combo w/Plastic PP Vented Lid	119
16oz Tall Paper Food Container Combo w/Plastic PP Vented Lid	120
16oz Squate Paper Food Container Combo w/Plastic PP Vented Lid	121
32oz Paper Food Container Combo w/Plastic PP Vented Lid	122

Paper Plates **123**

9" V-Line Round Paper Plate	124
-----------------------------	-----





Dear Valued Customer,

We've got a package for you.

YesPac is America's favorite manufacturer of cups and packaging solutions. With decades of experience producing high quality products, we are here to design the goods that make your business great.

In today's fast-paced environment, speed and efficiency are critical to your success. So we prioritize rapid turnaround times and efficient order fulfillment to help keep your operations running smoothly.

Our product line includes a wide variety of cups, including hot cups, plastic cups, and paper cups, as well as containers and plastic containers. Total control over our in-house manufacturing capabilities also enables fully custom products, sizes, shapes, and branding.

You will love our team! They're knowledgeable and responsive, and take pride in providing excellent service and support. We look forward to the opportunity to work with you and help your business thrive.

Sincerely,

A handwritten signature in black ink, appearing to read 'Abe Goldberger', is positioned above the printed name.

Abe Goldberger
Chief Executive Officer



Your single partner for all single-use products.

Work with an all-American company that offers cutting-edge package designs and programs that work for you, your business, and most importantly, your clients.

As one of the country's leaders in disposable specialties, we provide an extensive product line backed by the promise of efficiency, flexibility, and reliability.



412K+

Square foot total manufacturing and distribution footprint

200K+

Square foot total of the highest grade production equipment

1mm+

Collective clients serviced by our partnering distributors nationwide

Welcome to the land of “Yes, we can.”



Our company culture is all about showing up and stepping up. Here, everything is available, and any design is possible.

From paper to plastic, lightweight to heavy duty, we offer you an endless array of disposable solutions.



Hot Cups

Highly recyclable, clear, available in multiple sizes



Cold Cups

Paper, plastic, white, and clear



Clamshells

Highly recyclable, clear, available in multiple sizes



Deli Containers

Highly recyclable, clear, available in multiple sizes



Salad Bowls

Highly recyclable, clear, available in multiple sizes



Food Cups

Paper, white, available in multiple styles and sizes



Approval by the SQF signifies exceptional food safety and quality.

Your cup is our command.

Our capabilities only end where all your needs are met. We make it our mission to fill orders quickly, with nominal MOQs, fair prices, and a superior, long-term customer experience.



Latest Packaging Technologies



Fast, Efficient Production Schedules



Full Spectrum of Sustainable Materials



Customized Branding & Product Designs



Stock and supply with confidence.

With YesPac as your packaging partner, you rest easy knowing your clients are served the very best vessels—and with the fastest turnaround times in the game.

Quality Assurance

We meet and surpass industry standards, guaranteed

Superior Safety

Our Consumer Experience team prioritizes user safety

American Made

From design to manufacture, we do it all stateside

Custom Touch

We ensure each design is perfectly on brand, every time

Advanced Tech

Software ramps up logistics for reliable, rapid turnaround

Comprehensive Production

Optimized equipment advances capabilities for exceptional results

Fighting fast-food waste from within.

We are passionate about feeding people without starving the planet. Sustainable solutions are not only good for the environment but also good for business. That's why we take pride in delivering sustainable goods at accessible price points.

To help reduce carbon footprints, we strive to integrate a variety of environmentally friendly materials where possible. Our wide range of recyclable, reusable, biodegradable, and compostable options meet your most diverse and demanding needs.

We are also committed to reducing waste throughout our own manufacturing and distribution processes. YesPac implemented a number of measures to minimize waste and maximize efficiency, using energy-efficient equipment, reducing packaging materials, drawing on solar energy to power our facilities, and returning product scraps to upcycle them back through our manufacturing loop.

By partnering with YesPac, businesses can join our efforts to protect the environment and promote sustainability.



If you sell food, we help you serve.



 Restaurants

 Takeout & Delivery

 Food Retailers

 Cafeterias



 Coffee Shops

 Delicatessens

 Event Planners

 Caterers

Make your brand the main dish.



Customize your disposables with your brand design, colors, and other elements for a cohesive and recognizable brand image that promotes with every sip.

4oz Paper Single Wall Hot Cups

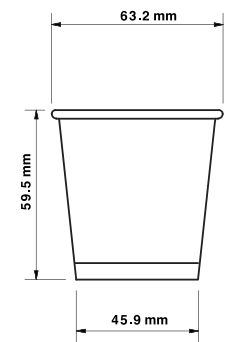

Packaging Configuration

Qty per carton: 1,000	Qty per layer: 6	Lbs per skid: 856.8
Qty per skid: 84,000	Layer per skid: 14	Box Dimensions: 13" x 10.5" x 15.0"
Lbs per carton: 10.2	Carton per skid: 84	Cubic Feet: 1.18

Designs / Item Numbers

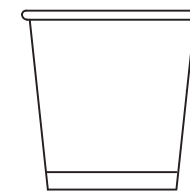

White
WC04



Classic
CLC04



Mocha
MHC04



Single Wall
Paper Hot Cup



6oz Paper Single Wall Hot Cup



Packaging Configuration

Qty per carton: 1,000	Qty per layer: 5	Lbs per skid: 810
Qty per skid: 50,000	Layer per skid: 10	Box Dimensions: 15" x 12.2" x 16.7"
Lbs per carton: 16.2	Carton per skid: 50	Cubic Feet: 1.77

Designs / Item Numbers

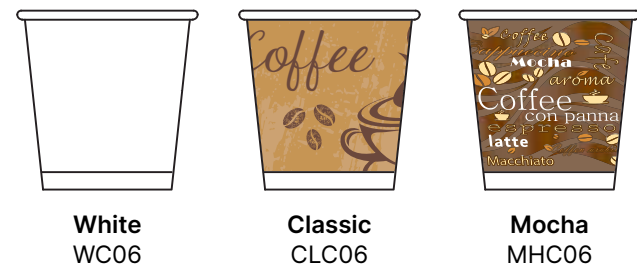

8oz Paper Single Wall Hot Cup

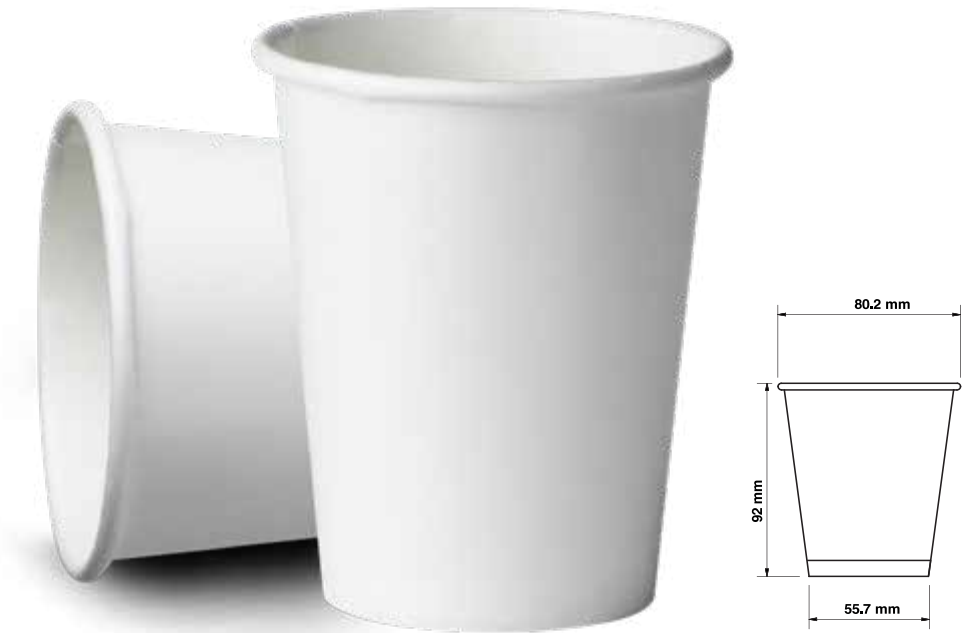

Packaging Configuration

Qty per carton: 1,000	Qty per layer: 8	Lbs per skid: 760
Qty per skid: 40,000	Layer per skid: 5	Box Dimensions: 15.9" x 10.4" x 15.8"
Lbs per carton: 19	Carton per skid: 40	Cubic Feet: 1.51

Designs / Item Numbers

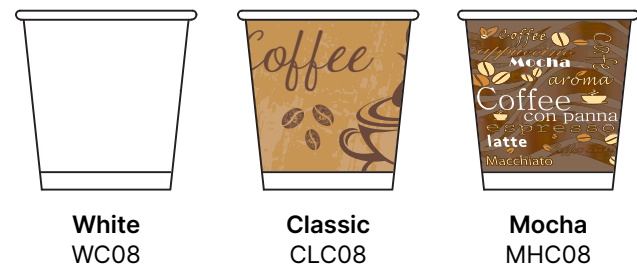

10oz Squat Single Wall Paper Hot Cups

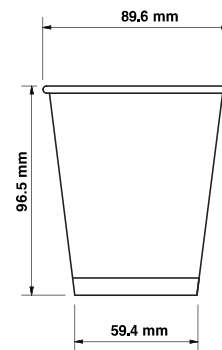

Packaging Configuration

Qty per carton: 1,000	Qty per layer: 6	Lbs per skid: 552
Qty per skid: 24,000	Layer per skid: 4	Box Dimensions: 17.9" x 14.4" x 17.9"
Lbs per carton: 23	Carton per skid: 24	Cubic Feet: 2.67

Designs / Item Numbers



12oz White Paper Hot Cup

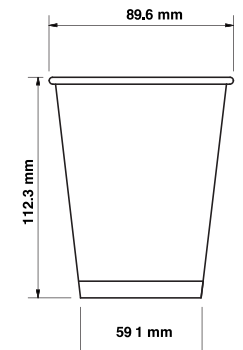

Packaging Configuration

Qty per carton: 1,000	Qty per layer: 6	Lbs per skid: 633.6
Qty per skid: 24,000	Layer per skid: 4	Box Dimensions: 18.1" x 14.5" x 20.6"
Lbs per carton: 26.4	Carton per skid: 24	Cubic Feet: 3.15

Designs / Item Numbers

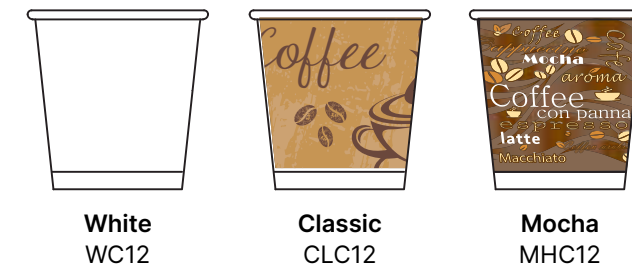

16oz Single Wall Paper Hot Cup

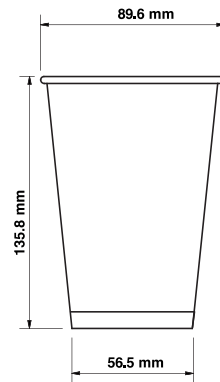

Packaging Configuration

Qty per carton: 1,000	Qty per layer: 6	Lbs per skid: 586.8
Qty per skid: 18,000	Layer per skid: 3	Box Dimensions: 17.9" x 14.4" x 22.8"
Lbs per carton: 32.6	Carton per skid: 18	Cubic Feet: 3.40

Designs / Item Numbers

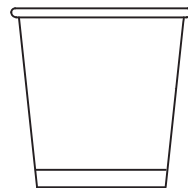

White
WC16



Classic
CLC16



Mocha
MHC16



20oz Single Wall Paper Hot Cup

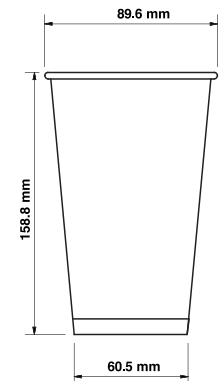

Packaging Configuration

Qty per carton: 500	Qty per layer: 6	Lbs per skid: 570
Qty per skid: 30,000	Layer per skid: 5	Box Dimensions: 18.1" x 14.5" x 18.5"
Lbs per carton: 19	Carton per skid: 30	Cubic Feet: 2.83

Designs / Item Numbers

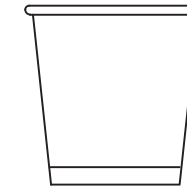

White
WC20



Classic
CLC20



Mocha
MHC20



24oz Single Wall Paper Hot Cup

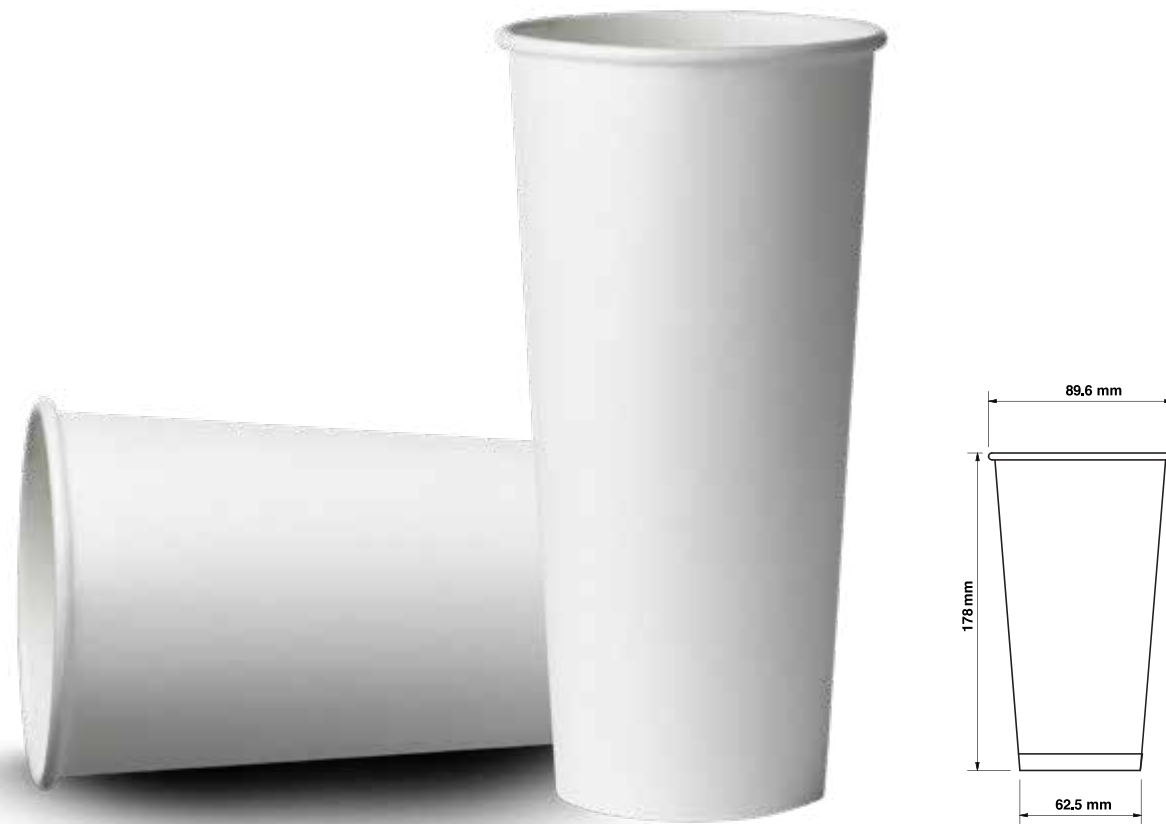

Packaging Configuration

Qty per carton: 500	Qty per layer: 6	Lbs per skid: 1528
Qty per skid: 36,000	Layer per skid: 4	Box Dimensions: 18.1" x 14." x 18.5"
Lbs per carton: 22	Carton per skid: 24	Cubic Feet: 2.83

Designs / Item Numbers

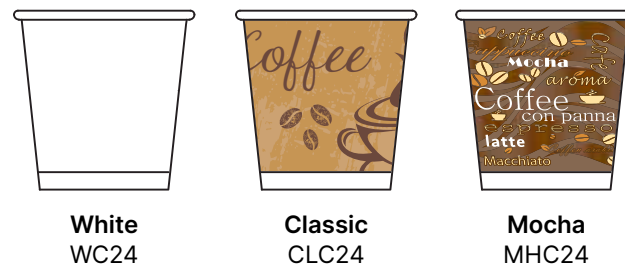

White
WC24

Classic
CLC24

Mocha
MHC24



Double Wall Paper Hot Cups

4oz Double Wall Paper Hot Cup

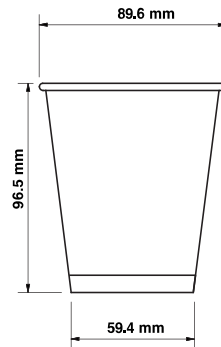

Packaging Configuration

Qty per carton: 500	Qty per layer: 6	Lbs per skid: 588
Qty per skid: 42,000	Layer per skid: 14	Box Dimensions: 3" x 10.5" x 15.0"
Lbs per carton: 7	Carton per skid: 84	Cubic Feet: 1.19

Designs / Item Numbers

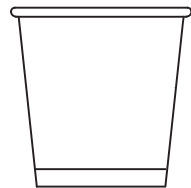

White
DWWC04



6oz Double Wall Paper Hot Cup

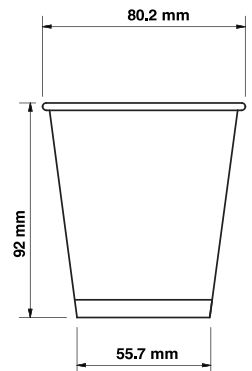

Packaging Configuration

Qty per carton: 500	Qty per layer: 9	Lbs per skid: 480
Qty per skid: 16,000	Layer per skid: 4	Box Dimensions: 14" x 17" x 22"
Lbs per carton: 15	Carton per skid: 36	Cubic Feet: 81"

Designs / Item Numbers

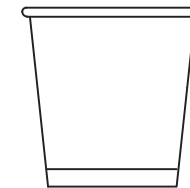

White
DWWC06



8oz Double Wall Paper Hot Cup

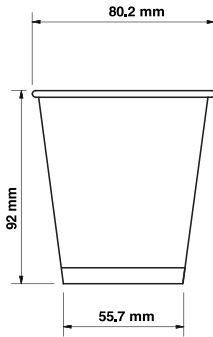

Packaging Configuration

Qty per carton: 500	Qty per layer: 8	Lbs per skid: 480
Qty per skid: 16,000	Layer per skid: 4	Box Dimensions: 14" x 17" x 22"
Lbs per carton: 15	Carton per skid: 32	Cubic Feet: 3.03

Designs / Item Numbers

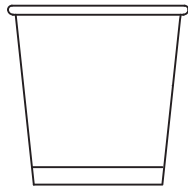

White
DWWC08

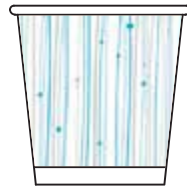

Vertical Line
YPDWVL08



10oz Double Wall Paper Hot Cup

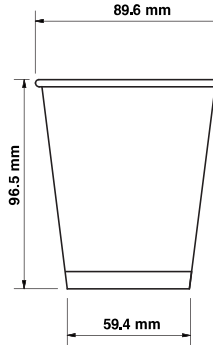

Packaging Configuration

Qty per carton: 500	Qty per layer: 6	Lbs per skid: 648
Qty per skid: 12,000	Layer per skid: 4	Box Dimensions: 18" x 15" x 20"
Lbs per carton: 27	Carton per skid: 24	Cubic Feet: 3.13

Designs / Item Numbers

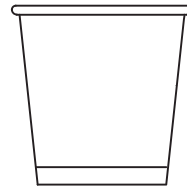

White
DWWC10

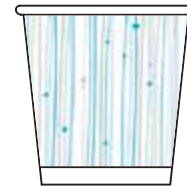

Vertical Line
YPDWVL10



12oz Double Wall Paper Hot Cup

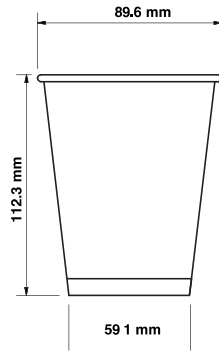

Packaging Configuration

Qty per carton: 520	Qty per layer: 6	Lbs per skid: 275.4
Qty per skid: 9,360	Layer per skid: 3	Box Dimensions: 21.5" x 16.5" x 14"
Lbs per carton: 15.3	Carton per skid: 18	Cubic Feet: 2.87

Designs / Item Numbers

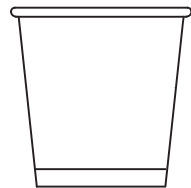

White
DWWC10

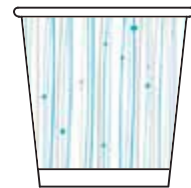

Vertical Line
YPDWVL12



16oz Double Wall Paper Hot Cup

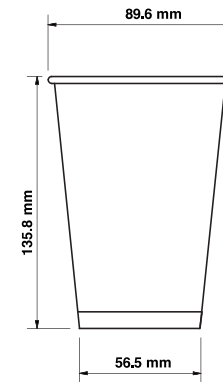
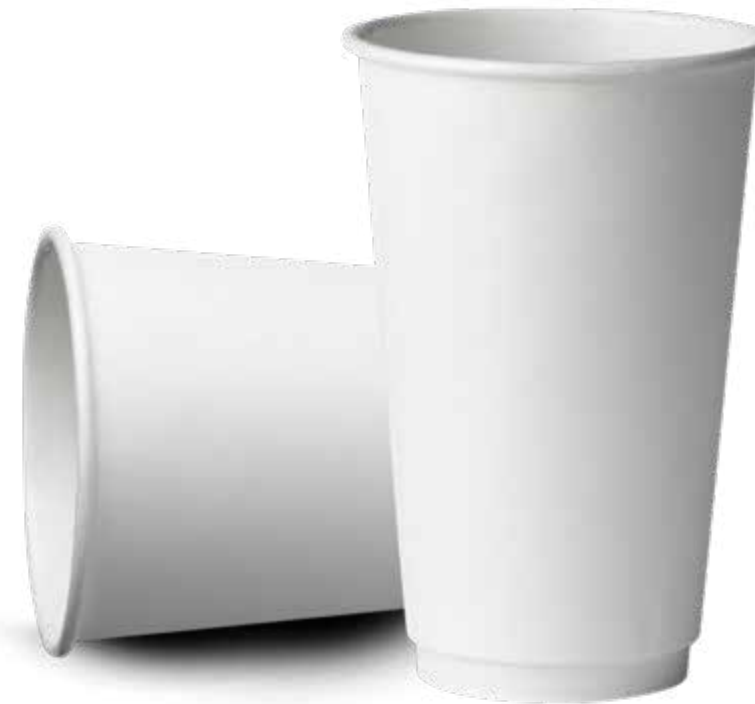

Packaging Configuration

Qty per carton: 440	Qty per layer: 6	Lbs per skid: 275.4
Qty per skid 7,920	Layer per skid: 3	Box Dimensions: 21.5" x 16.5" x 14"
Lbs per carton: 15.3	Carton per skid: 18	Cubic Feet: 2.87

Designs / Item Numbers

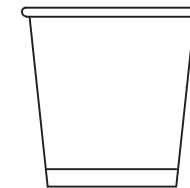

White
DWWC16

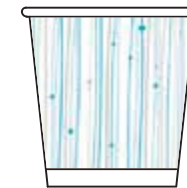

Vertical Line
YPDWVL16



20oz Double Wall Paper Hot Cup

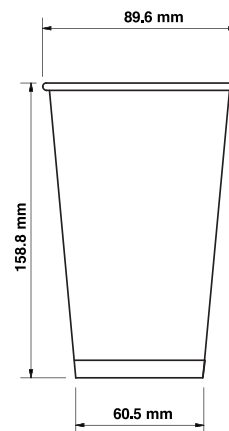

Packaging Configuration

Qty per carton: 340	Qty per layer: 6	Lbs per skid: 275.4
Qty per skid 7,920	Layer per skid: 3	Box Dimensions: 21.5" x 16.5" x 14"
Lbs per carton: 15.3	Carton per skid: 18	Cubic Feet: 2.87

Designs / Item Numbers

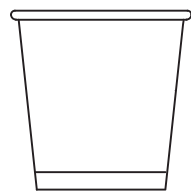

White
DWWC20

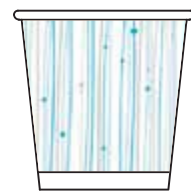

Vertical Line
YPDWVL20



Kraft Stock Double Wall Hot Cups

8oz Kraft Stock Double Wall Hot Cup

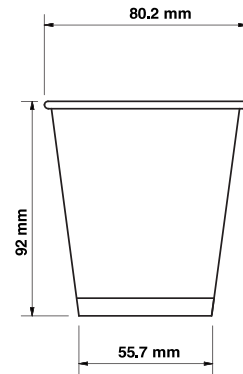

Packaging Configuration

Qty per carton: 500	Qty per layer: 8	Lbs per skid: 480
Qty per skid: 16,000	Layer per skid: 4	Box Dimensions: 14" x 17" x 22"
Lbs per carton: 15	Carton per skid: 32	Cubic Feet: 3.03

Designs / Item Numbers

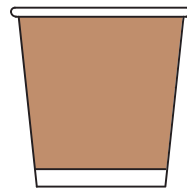

Kraft
HCP803



10oz Kraft Stock Double Wall Hot Cup

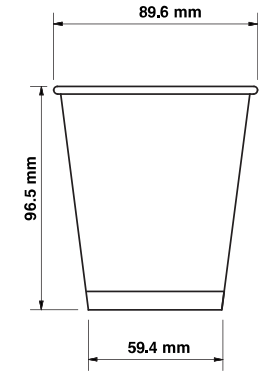

Packaging Configuration

Qty per carton: 500	Qty per layer: 6	Lbs per skid: 648
Qty per skid: 12,000	Layer per skid: 4	Box Dimensions: 18" x 15" x 20"
Lbs per carton: 27	Carton per skid: 24	Cubic Feet:

Designs / Item Numbers

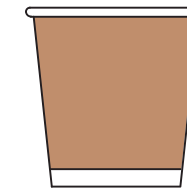

Kraft
DWKR10



12oz Kraft Stock Double Wall Hot Cup



Packaging Configuration

Qty per carton: 520	Qty per layer: 6	Lbs per skid: 275.4
Qty per skid: 9,360	Layer per skid: 3	Box Dimensions: 21.5" x 16.5" x 14"
Lbs per carton: 15.3	Carton per skid: 18	Cubic Feet: 2.87

Designs / Item Numbers

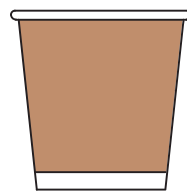

Kraft
DWKR12



16oz Kraft Stock Double Wall Hot Cup



Packaging Configuration

Qty per carton: 440	Qty per layer: 6	Lbs per skid: 275.4
Qty per skid 7,920	Layer per skid: 3	Box Dimensions: 21.5" x 16.5" x 14"
Lbs per carton: 15.3	Carton per skid: 18	Cubic Feet: 2.87

Designs / Item Numbers

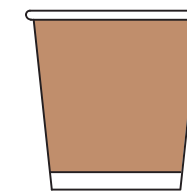

Kraft
DWKR16



20oz Kraft Stock Double Wall Hot Cup

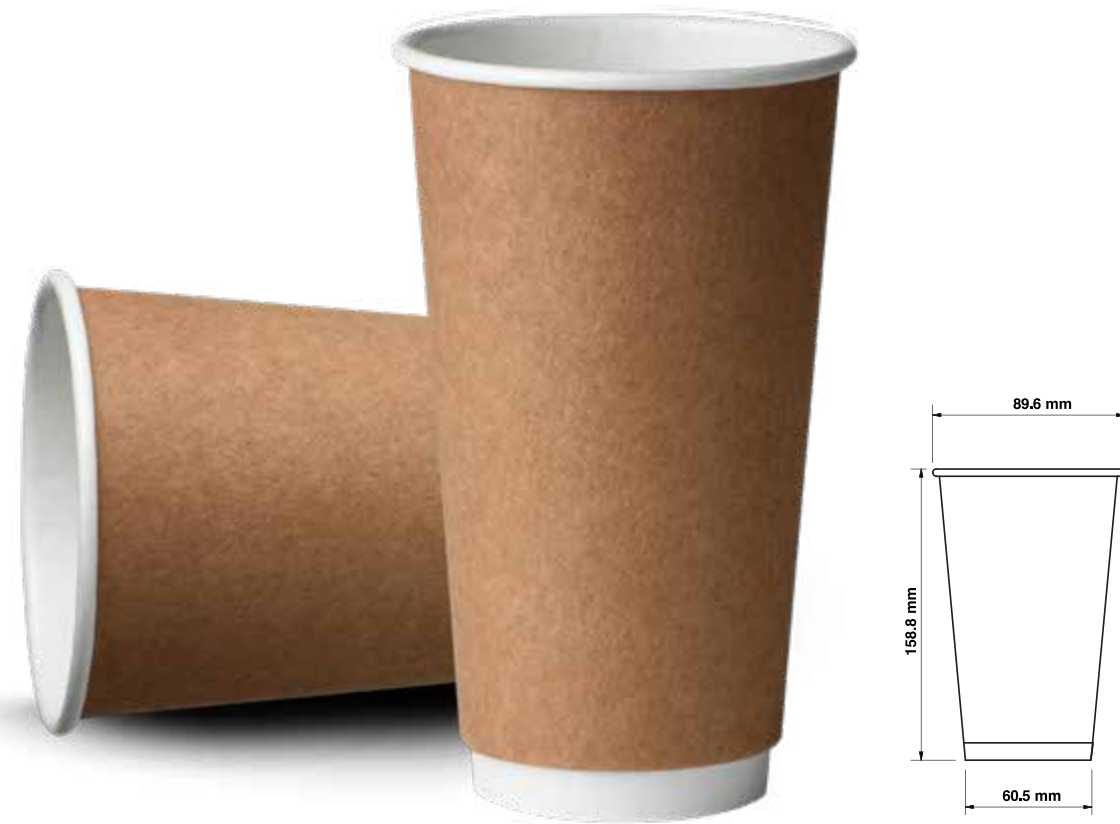

Packaging Configuration

Qty per carton: 340	Qty per layer: 6	Lbs per skid 275.4
Qty per skid: 6,120	Layer per skid: 3	Box Dimensions: 21.5" x 16.5" x 14"
Lbs per carton: 15.3	Carton per skid: 18	Cubic Feet:

Designs / Item Numbers

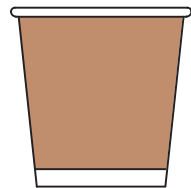

Kraft
DWKR20



Paper
Cold Cups

4.5oz Cone Water Cups-Rolled Rim



Packaging Configuration

Qty per carton: 5,000	Qty per layer: 9	Lbs per skid: 864
Qty per skid: 180,000	Layer per skid: 4	Box Dimensions: 15" x 18" x 15"
Lbs per carton: 24	Carton per skid: 36	Cubic Feet: 2.34

Designs / Item Numbers

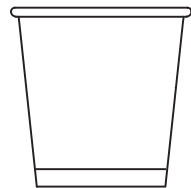

White
WCC4.5CW

4oz Single Wall Paper Cold Cup



Packaging Configuration

Qty per carton: 1,000	Qty per layer: 6	Lbs per skid: 856.8
Qty per skid: 84,000	Layer per skid: 14	Box Dimensions: 13" x 10.5" x 15.0"
Lbs per carton: 10.2	Carton per skid: 84	Cubic Feet: 1.18

Designs / Item Numbers

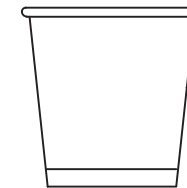

White
WCC04



6oz Single Wall Paper Cold Cup



Packaging Configuration

Qty per carton: 1,000	Qty per layer: 5	Lbs per skid: 810
Qty per skid: 84,000	Layer per skid: 10	Box Dimensions: 15" x 12.2" x 16.7"
Lbs per carton: 16.2	Carton per skid: 50	Cubic Feet: 1.77

Designs / Item Numbers

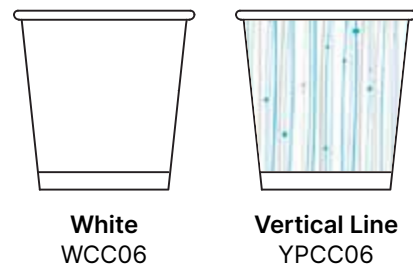

White
WCC06

Vertical Line
YPCC06



8oz Single Wall Paper Cold Cup

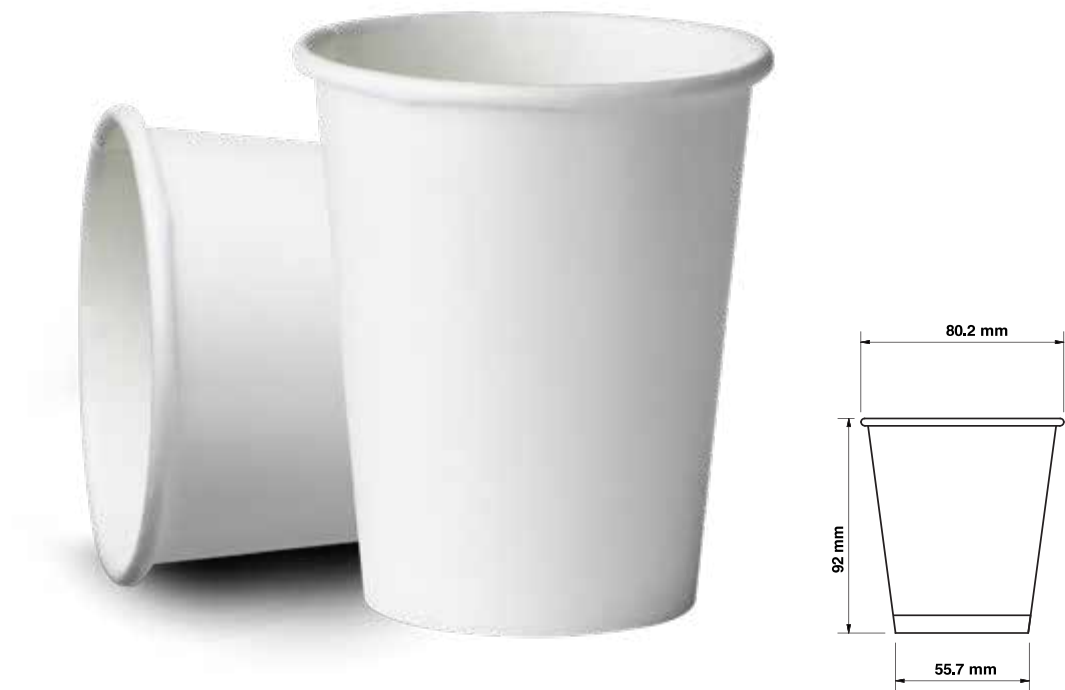

Packaging Configuration

Qty per carton: 1,000	Qty per layer: 8	Lbs per skid: 600
Qty per skid: 40,000	Layer per skid: 5	Box Dimensions: 16.4" x 13" x 18.5"
Lbs per carton: 15	Carton per skid: 40	Cubic Feet: 2.28

Designs / Item Numbers

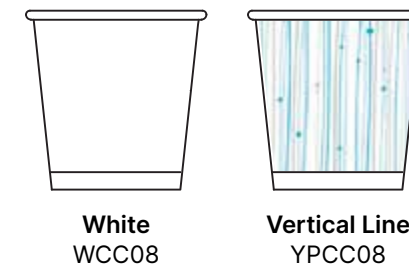

White
WCC08

Vertical Line
YPCC08



10oz Single Wall Paper Cold Cup

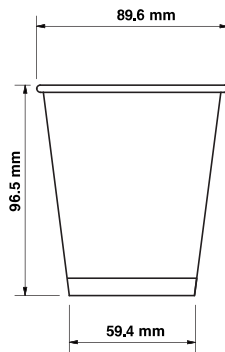

Packaging Configuration

Qty per carton: 1,000	Qty per layer: 6	Lbs per skid: 408
Qty per skid: 24,000	Layer per skid: 4	Box Dimensions: 17.9" x 14.4" x 17.9"
Lbs per carton: 17	Carton per skid: 40	Cubic Feet: 2.67

Designs / Item Numbers

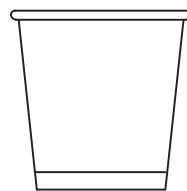

White
WCC10

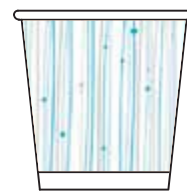

Vertical Line
YPCC10



12oz Single Wall Paper Cold Cup

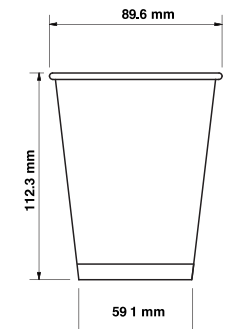

Packaging Configuration

Qty per carton: 1,000	Qty per layer: 6	Lbs per skid: 576
Qty per skid: 24,000	Layer per skid: 4	Box Dimensions: 17.9" x 14.4" x 17.9"
Lbs per carton: 21	Carton per skid: 24	Cubic Feet: 2.67

Designs / Item Numbers

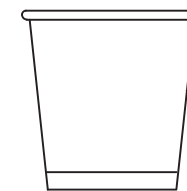

White
WCC12

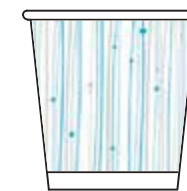

Vertical Line
YPCC12



14oz Single Wall Paper Cold Cup

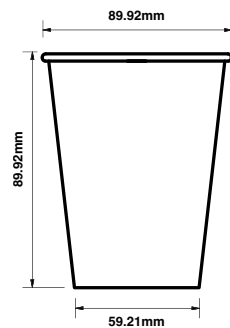

Packaging Configuration		
Qty per carton: 1,000	Qty per layer: 6	Lbs per skid: 552
Qty per skid: 24,000	Layer per skid: 4	Box Dimensions: 17.9" x 14.4" x 19.3"
Lbs per carton: 23	Carton per skid: 24	Cubic Feet:

Designs / Item Numbers

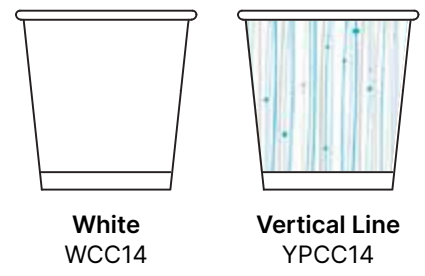

16oz Single Wall Paper Cold Cup

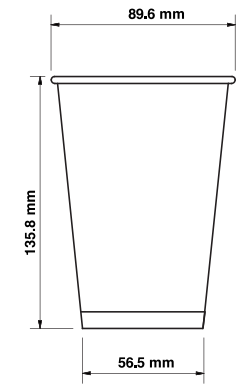

Packaging Configuration		
Qty per carton: 1,000	Qty per layer: 6	Lbs per skid: 468
Qty per skid: 18,000	Layer per skid: 3	Box Dimensions: 17.9" x 14.4" x 22.8"
Lbs per carton: 26	Carton per skid: 18	Cubic Feet: 2.88

Designs / Item Numbers

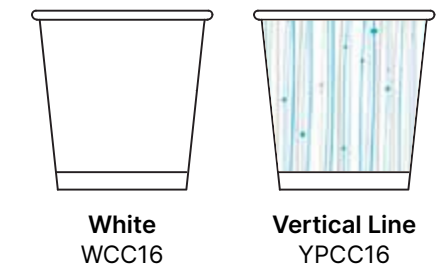

20oz Single Wall Paper Cold Cup



Packaging Configuration

Qty per carton: 1,000	Qty per layer: 6	Lbs per skid: 648
Qty per skid: 18,000	Layer per skid: 3	Box Dimensions: 27.5" x 18.5" x 14.75"
Lbs per carton: 36	Carton per skid: 18	Cubic Feet: 3.40

Designs / Item Numbers

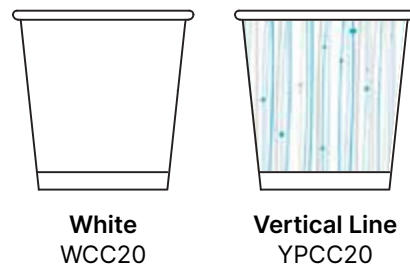

White
WCC20

Vertical Line
YPCC20



21oz Single Wall Paper Cold Cup

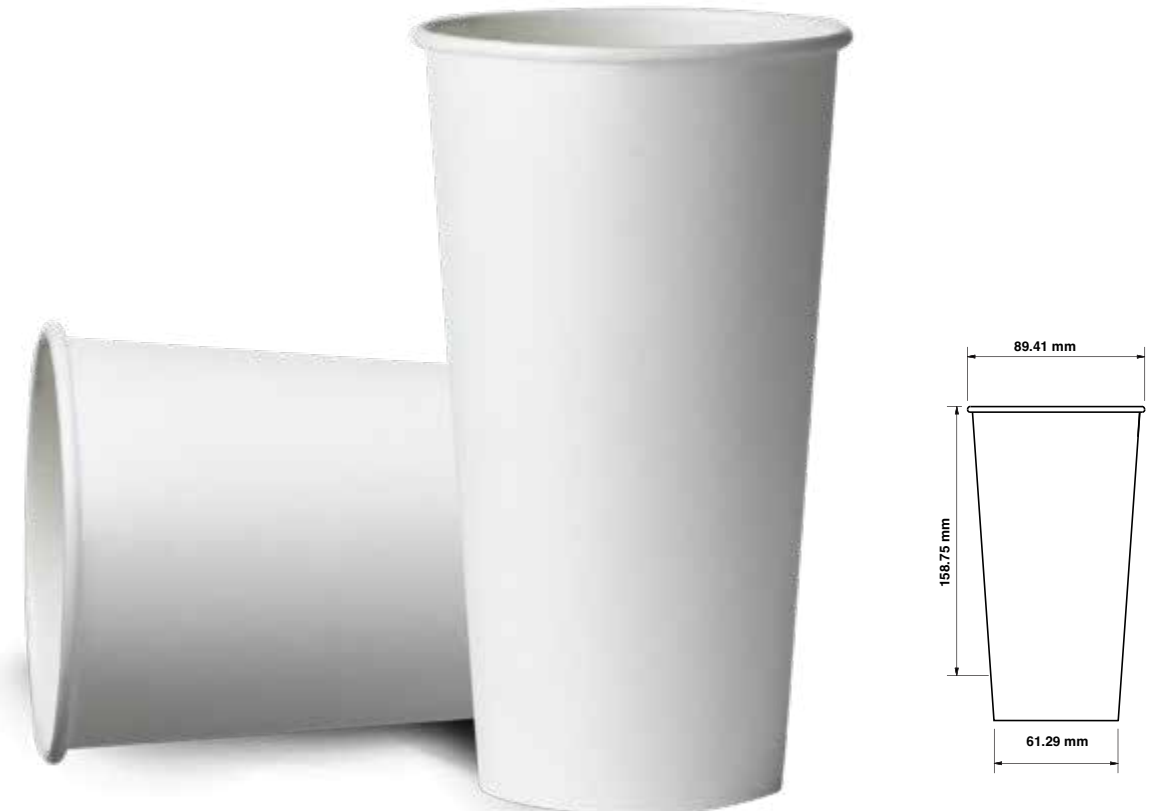

Packaging Configuration

Qty per carton: 1,000	Qty per layer: 6	Lbs per skid: 468
Qty per skid: 18,000	Layer per skid: 3	Box Dimensions: 17.9" x 14.4" x 22.8"
Lbs per carton: 26	Carton per skid: 18	Cubic Feet: 3.79

Designs / Item Numbers

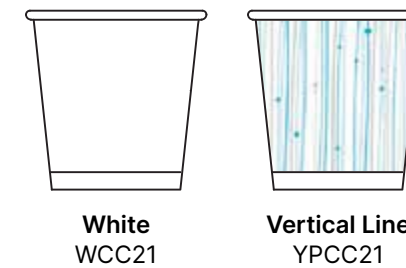

White
WCC21

Vertical Line
YPCC21



22oz Single Wall Paper Cold Cup



Packaging Configuration

Qty per carton: 1,000	Qty per layer: 6	Lbs per skid: 648
Qty per skid: 18,000	Layer per skid: 3	Box Dimensions: 27.5" x 18.5" x 14.75"
Lbs per carton: 36	Carton per skid: 18	Cubic Feet: 4.34

Designs / Item Numbers

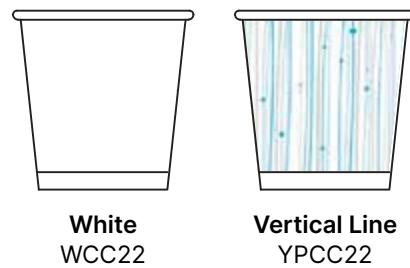

White
WCC22

Vertical Line
YPCC22



24oz Single Wall Paper Cold Cup



Packaging Configuration

Qty per carton: 500	Qty per layer: 6	Lbs per skid: 480
Qty per skid: 12,000	Layer per skid: 4	Box Dimensions: 17.9" x 14.4" x 17.9"
Lbs per carton: 20	Carton per skid: 24	Cubic Feet: 2.67

Designs / Item Numbers

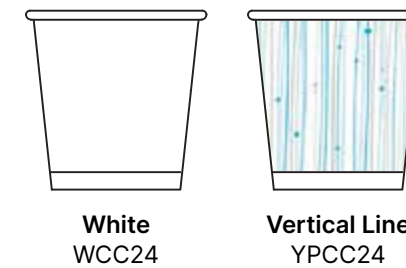

White
WCC24

Vertical Line
YPCC24



32oz White Single Wall Paper Cold Cup

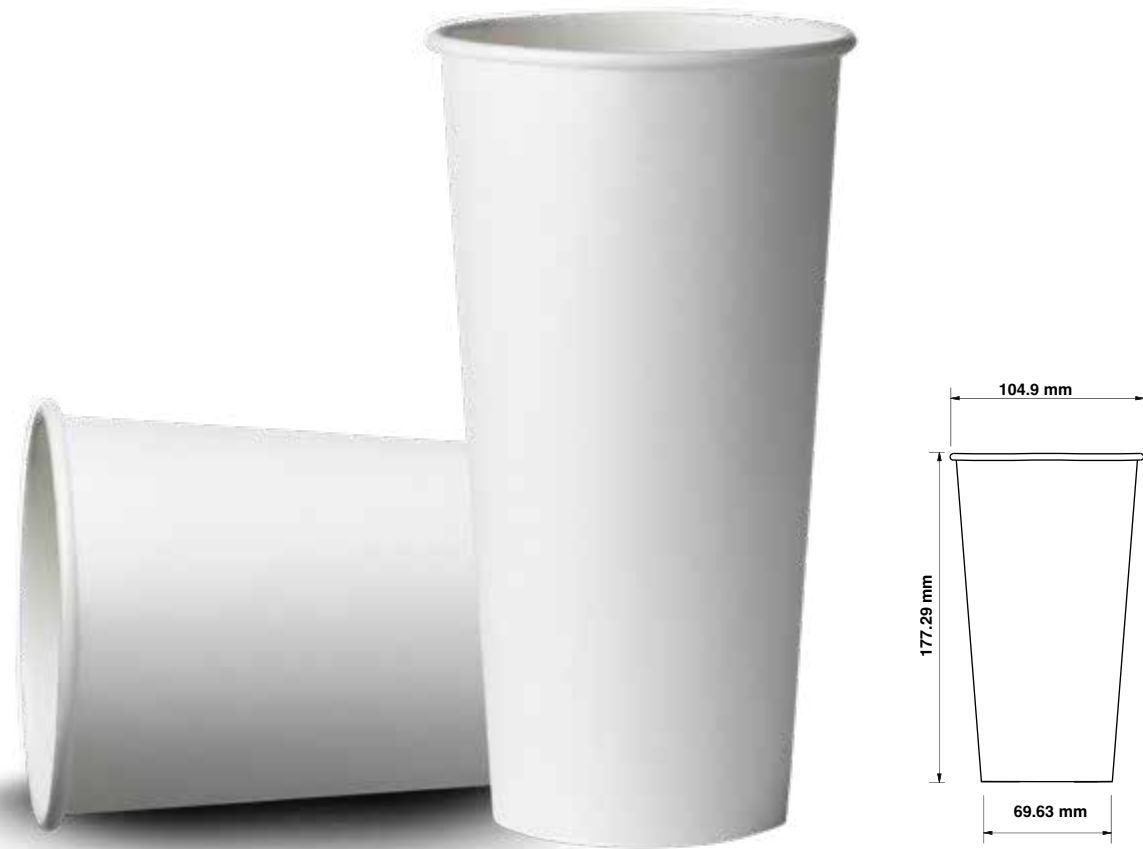

Packaging Configuration

Qty per carton: 500	Qty per layer: 6	Lbs per skid: 624
Qty per skid: 12,000	Layer per skid: 4	Box Dimensions: 2075" x 16.5" x 16.75"
Lbs per carton: 26	Carton per skid: 24	Cubic Feet: 3.32

Designs / Item Numbers

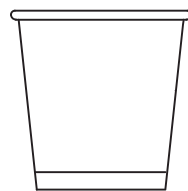

White
WCC32

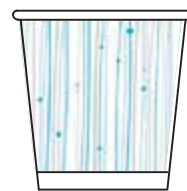

Vertical Line
YPCC32



Cup Lids

Polystyrene Hot Cup Dome Lids fits 4oz



Packaging Configuration

Qty per carton: 1000	Qty per layer: 12	Lbs per skid: 432
Qty per skid 108,000	Layer per skid: 9	Box Dimensions: 13.375" x 10.75" x 8.75"
Lbs per carton: 4	Carton per skid: 108	Cubic Feet: 0.73

Designs / Item Numbers



White
DLW-4

Polystyrene Hot Cup Dome Lids fits 6oz



Packaging Configuration

Qty per carton: 1000	Qty per layer: 18	Lbs per skid: 360
Qty per skid 72,000	Layer per skid: 9	Box Dimensions: 15.75" x 6.5" x 18.75"
Lbs per carton: 5	Carton per skid: 72	Cubic Feet: 1.11

Designs / Item Numbers



White
DLW-6

Polypropylene Hot Cup Dome Lids fits 8oz



Packaging Configuration		
Qty per carton: 1000	Qty per layer: 8	Lbs per skid: 512
Qty per skid: 64,000	Layer per skid: 8	Box Dimensions: 17"x14"x12"
Lbs per carton: 8	Carton per skid: 64	Cubic Feet: 1.65

Designs / Item Numbers

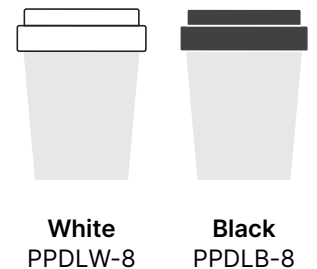

White PPDLW-8 Black PPDLB-8

Polypropylene Hot Cup Dome Lids fits 10oz - 24oz



Packaging Configuration		
Qty per carton: 1000	Qty per layer: 6	Lbs per skid: 480
Qty per skid: 48,000	Layer per skid: 8	Box Dimensions: 19"x15 1/2" x 12 1/2"
Lbs per carton: 10	Carton per skid: 48	Cubic Feet: 1.65

Designs / Item Numbers

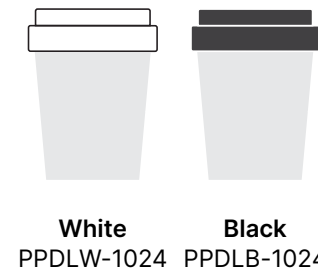

White PPDLW-1024 Black PPDLB-1024

Clear PET Cold Cup Flat Straw Slot Lids fits 12oz - 24oz

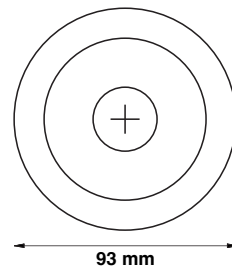

Packaging Configuration

Qty per carton: 1000	Qty per layer: 12	Lbs per skid: 540
Qty per skid: 60,000	Layer per skid: 5	Box Dimensions: 20.5" x 8.5" x 17"
Lbs per carton: 9	Carton per skid: 60	Cubic Feet: 2.30

Designs / Item Numbers



Clear
PTFSL-1224

Clear PET Dome Lids for Paper Cold Cups fits 8/9oz



Packaging Configuration

Qty per carton: 1000	Qty per layer: 12	Lbs per skid: 540
Qty per skid: 60,000	Layer per skid: 5	Box Dimensions: 20.5" x 8.5" x 17"
Lbs per carton: 9	Carton per skid: 60	Cubic Feet: 2.30

Designs / Item Numbers



Clear
PTDL-0809

Clear PET Flat Lids for Paper Cold Cups fits 8/9oz

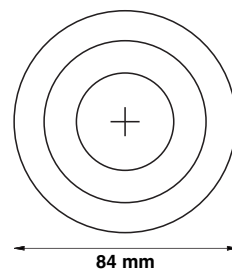

Packaging Configuration

Qty per carton: 1000	Qty per layer: 12	Lbs per skid: 540
Qty per skid: 60,000	Layer per skid: 5	Box Dimensions: 20.5" x 8.5" x 17"
Lbs per carton: 9	Carton per skid: 60	Cubic Feet: 1.62

Designs / Item Numbers



Clear
PTFL-0809



PET Cups

12oz PET Clear Plastic Cold Cups

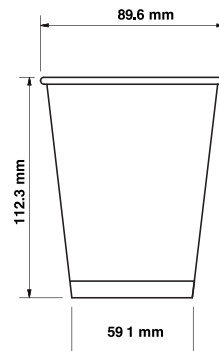

Packaging Configuration

Qty per carton: 1,000	Qty per layer: 6	Lbs per skid: 696
Qty per skid: 24,000	Layer per skid: 4	Box Dimensions: 20.438" x 16.438" x 17
Lbs per carton: 29	Carton per skid: 24	Cubic Feet: 3.31

Item Number



Clear
PLCC12



16oz PET Clear Plastic Cold Cups

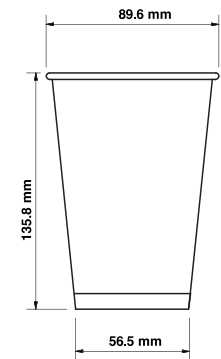

Packaging Configuration

Qty per carton: 1,000	Qty per layer: 6	Lbs per skid: 816
Qty per skid: 24,000	Layer per skid: 4	Box Dimensions: 19.625" x 15.625" x 19
Lbs per carton: 34	Carton per skid: 24	Cubic Feet: 3.37

Item Number



Clear
PLCC16



18oz Salad Bowl



Packaging Configuration

Qty per carton: 150	Qty per layer: 12	Lbs per skid: 612
Qty per skid: 9,000	Layer per skid: 5	Box Dimensions: 21.1" x 7.5" x 15.75"
Lbs per carton: 10.2	Carton per skid: 60	Cubic Feet: 1.48

Item Number SB18



Salad Bowls



24oz Salad Bowl



Packaging Configuration

Qty per carton: 150	Qty per layer: 12	Lbs per skid: 612
Qty per skid: 9,000	Layer per skid: 5	Box Dimensions: 21.1" x 7.5" x 15.75"
Lbs per carton: 10.2	Carton per skid: 60	Cubic Feet:

Item Number	SB24
-------------	------

32oz Salad Bowl



Packaging Configuration

Qty per carton: 150	Qty per layer: 12	Lbs per skid: 684
Qty per skid: 9,000	Layer per skid: 4	Box Dimensions: 21.5" x 7.5" x 18"
Lbs per carton: 11.4	Carton per skid: 60	Cubic Feet: 1.67

Item Number	SB32
-------------	------

48oz Salad Bowl



Packaging Configuration

Qty per carton: 150	Qty per layer: 12	Lbs per skid: 804
Qty per skid: 9,000	Layer per skid: 4	Box Dimensions: 21.5" x 7.5" x 18"
Lbs per carton: 13.4	Carton per skid: 60	Cubic Feet: 1.67

Item Number SB48

24z Salad Bowl Bulk (Bowl Only)



Packaging Configuration

Qty per carton: 300	Qty per layer: 12	Lbs per skid: 744
Qty per skid: 14,000	Layer per skid: 4	Box Dimensions: 21.5" x 7.5" x 18"
Lbs per carton: 15.5	Carton per skid: 48	Cubic Feet: 1.67

Item Number SB24B

32oz Salad Bowl Bulk (Bowl Only)



Packaging Configuration

Qty per carton: 300	Qty per layer: 12	Lbs per skid: 744
Qty per skid: 14,000	Layer per skid: 4	Box Dimensions: 21.5" x 7.5" x 18"
Lbs per carton: 15.5	Carton per skid: 48	Cubic Feet: 1.67

Item Number SB32B



Clamshell Containers

6" x 6" x 3" Clamshell

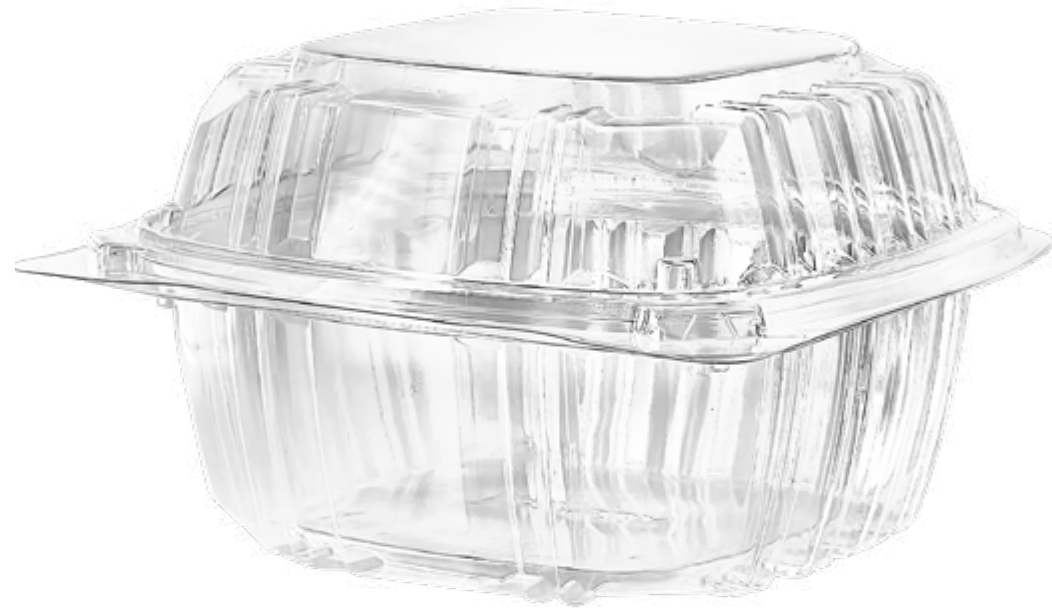

Packaging Configuration

Qty per carton: 500	Qty per layer: 6	Lbs per skid: 559.2
Qty per skid: 12,000	Layer per skid: 3	Box Dimensions: 27.5" x 13" x 24.5"
Lbs per carton: 23.3	Carton per skid: 24	Cubic Feet: 4.85

Item Number HCP602

6"x6"x3 3/8" Clamshell



Packaging Configuration

Qty per carton: 500	Qty per layer: 6	Lbs per skid: 559.2
Qty per skid: 12,000	Layer per skid: 3	Box Dimensions: 27.5" x 13" x 24.5"
Lbs per carton: 23.3	Carton per skid: 24	Cubic Feet: 4.85

Item Number HCP603

8"x8"x2 3/4" Clamshell

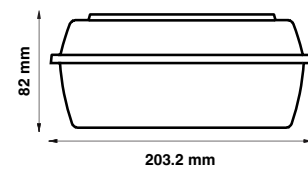

Packaging Configuration

Qty per carton: 200	Qty per layer: 6	Lbs per skid: 630
Qty per skid: 7,200	Layer per skid: 5	Box Dimensions: 17" x 21" x 16.625"
Lbs per carton: 17.5	Carton per skid: 36	Cubic Feet: 3.30

Item Number HCP802

8"x8"x3 3/8" Clamshell



Packaging Configuration

Qty per carton: 200	Qty per layer: 6	Lbs per skid: 630
Qty per skid: 7,200	Layer per skid: 5	Box Dimensions: 17" x 21" x 16.625"
Lbs per carton: 17.5	Carton per skid: 36	Cubic Feet: 3.30

Item Number HCP803

8"x8"x3 3/8" 3 Compartment Clamshell



Packaging Configuration

Qty per carton: 200	Qty per layer: 6	Lbs per skid: 630
Qty per skid: 7,200	Layer per skid: 5	Box Dimensions: 17" x 21" x 16.625"
Lbs per carton: 17.5	Carton per skid: 36	Cubic Feet: 3.30

Item Number	HCP804
-------------	--------

9"x9"x3" Clamshell



Packaging Configuration

Qty per carton: 200	Qty per layer: 4	Lbs per skid: 500
Qty per skid: 4,000	Layer per skid: 4	Box Dimensions: 21" x 19" x 19"
Lbs per carton: 25	Carton per skid: 20	Cubic Feet: 4.38

Item Number	HCP903
-------------	--------

9"x9"x3" 3 Compartment Clamshell



Packaging Configuration

Qty per carton: 200	Qty per layer: 4	Lbs per skid: 500
Qty per skid: 4,000	Layer per skid: 4	Box Dimensions: 21" x 19" x 19"
Lbs per carton: 25	Carton per skid: 20	Cubic Feet: 4.38

Item Number HCP904

9"x9"x3 1/2" Clamshell



Packaging Configuration

Qty per carton: 200	Qty per layer: 4	Lbs per skid: 520
Qty per skid: 4,000	Layer per skid: 4	Box Dimensions: 21" x 19" x 19"
Lbs per carton: 26	Carton per skid: 20	Cubic Feet: 4.38

Item Number HCP905

9 3/10" x 5 1/2" x 3 1/3" Smooth Wall Hinge Container

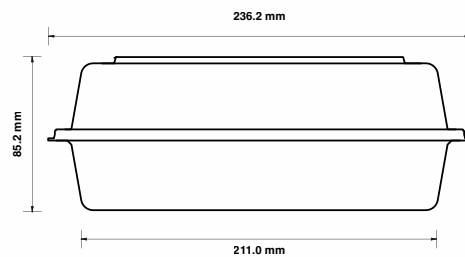

Packaging Configuration

Qty per carton: 400	Qty per layer: 4	Lbs per skid: 720
Qty per skid: 8,000	Layer per skid: 4	Box Dimensions: 22.5" x 19" x 19"
Lbs per carton: 36	Carton per skid: 20	Cubic Feet:

Item Number SWP95

9 3/8" x 6 3/4" x 2 3/16" Smooth Wall Hinge Container

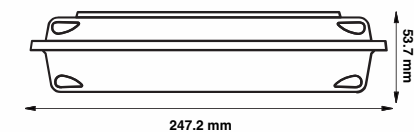

Packaging Configuration

Qty per carton: 250	Qty per layer: 6	Lbs per skid: 510.48
Qty per skid: 9,360	Layer per skid: 3	Box Dimensions: 20" x 12" x 22 11/16"
Lbs per carton: 28.36	Carton per skid: 18	Cubic Feet:

Item Number SWP97

6"x6"x3" Smooth Wall Clamshell

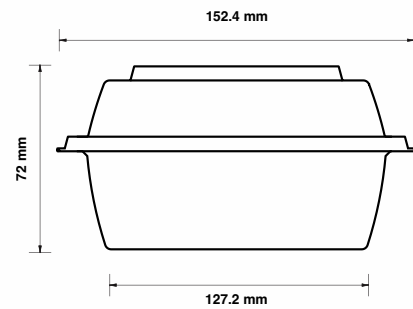

Packaging Configuration

Qty per carton: 500	Qty per layer: 6	Lbs per skid: 624
Qty per skid: 8,000	Layer per skid: 3	Box Dimensions: 27.5" x 13" x 24.5"
Lbs per carton: 26	Carton per skid: 24	Cubic Feet: 4.85

Item Number SWP602

6"x6"x3 3/8" Smooth Wall Clamshell

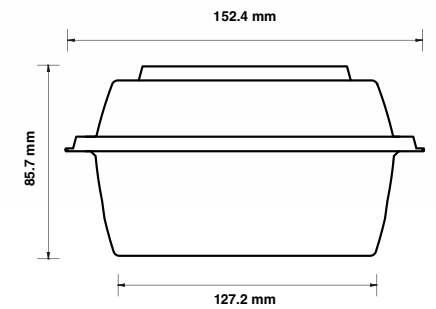

Packaging Configuration

Qty per carton: 500	Qty per layer: 6	Lbs per skid: 624
Qty per skid: 8,000	Layer per skid: 3	Box Dimensions: 27.5" x 13" x 24.5"
Lbs per carton: 26	Carton per skid: 24	Cubic Feet: 4.85

Item Number SWP603

24 oz Oblong Deli Container Only



Packaging Configuration

Qty per carton: 512	Qty per layer: 4	Lbs per skid: 312
Qty per skid: 8,192	Layer per skid: 4	Box Dimensions: 26 1/2" x 15 1/2" x 19"
Lbs per carton: 19.5	Carton per skid: 16	Cubic Feet: 4.51

Item Number **PT2401**



**Deli
Containers**



24 oz Oblong Deli Container with Dome Lid



Packaging Configuration

Qty per carton: 256	Qty per layer: 4	Lbs per skid: 312
Qty per skid: 4,096	Layer per skid: 4	Box Dimensions: 26 1/2" x 15 1/2" x 19"
Lbs per carton: 19.5	Carton per skid: 16	Cubic Feet: 4.51

Item Number PT2401PDL

24oz Oblong Deli Container with Flat Lid



Packaging Configuration

Qty per carton: 256	Qty per layer: 4	Lbs per skid: 312
Qty per skid: 4,096	Layer per skid: 4	Box Dimensions: 26 1/2" x 15 1/2" x 19"
Lbs per carton: 19.5	Carton per skid: 16	Cubic Feet: 4.51

Item Number PT2401CPFL

32 oz Oblong Deli Container Only



Packaging Configuration

Qty per carton: 512	Qty per layer: 4	Lbs per skid: 312
Qty per skid: 8,192	Layer per skid: 4	Box Dimensions: 26 1/2" x 15 1/2" x 19"
Lbs per carton: 19.5	Carton per skid: 16	Cubic Feet: 4.51

Item Number PT2401CPDL

32oz Oblong Deli Container with Dome Lid



Packaging Configuration

Qty per carton: 256	Qty per layer: 4	Lbs per skid: 312
Qty per skid: 4,096	Layer per skid: 4	Box Dimensions: 26 1/2" x 15 1/2" x 19"
Lbs per carton: 19.5	Carton per skid: 16	Cubic Feet: 4.51

Item Number PT3201DL



32oz Oblong Deli Container with Flat Lid



Packaging Configuration

Qty per carton: 256	Qty per layer: 4	Lbs per skid: 312
Qty per skid: 4,096	Layer per skid: 4	Box Dimensions: 26 1/2" x 15 1/2" x 19"
Lbs per carton: 19.5	Carton per skid: 16	Cubic Feet: 4.51

Item Number PT3201CPFL

Flat Lids for 24 & 32oz Oblong Deli Container



Packaging Configuration

Qty per carton: 512	Qty per layer: 4	Lbs per skid: 312
Qty per skid: 8,192	Layer per skid: 4	Box Dimensions: 26 1/2" x 15 1/2" x 19"
Lbs per carton: 19.5	Carton per skid: 16	Cubic Feet: 4.51

Item Number PT2432FL

Dome Lids for 24 & 32oz Oblong Deli Container



Packaging Configuration

Qty per carton: 512	Qty per layer: 4	Lbs per skid: 312
Qty per skid: 8,192	Layer per skid: 4	Box Dimensions: 26 1/2" x 15 1/2" x 19"
Lbs per carton: 19.5	Carton per skid: 16	Cubic Feet: 4.51

Item Number PT2432DL



Paper Food Containers



8oz Paper Food Container Bulk

(No Lid)

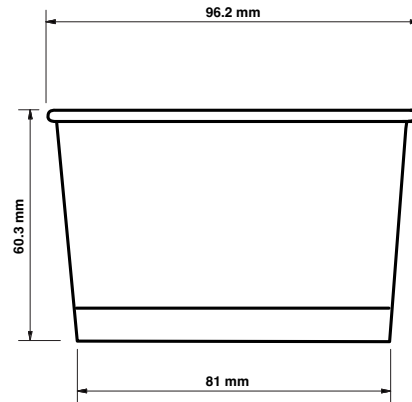

Packaging Configuration

Qty per carton: 1,000	Qty per layer: 6	Lbs per skid: 552
Qty per skid: 24,000	Layer per skid: 3	Box Dimensions: 19.75" x 15.5" x 20.25"
Lbs per carton: 23	Carton per skid: 24	Cubic Feet: 3.59

Designs / Item Numbers



White
PFCW08B



12oz Paper Food Container Bulk

(No Lid)

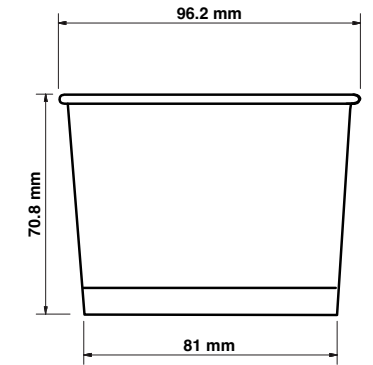

Packaging Configuration

Qty per carton: 1,000	Qty per layer: 6	Lbs per skid: 576
Qty per skid: 24,000	Layer per skid: 4	Box Dimensions: 19.75" x 15.5" x 20.375"
Lbs per carton: 24	Carton per skid: 24	Cubic Feet: 3.61

Designs / Item Numbers



White
PFCW12B



16oz Squat Paper Food Container

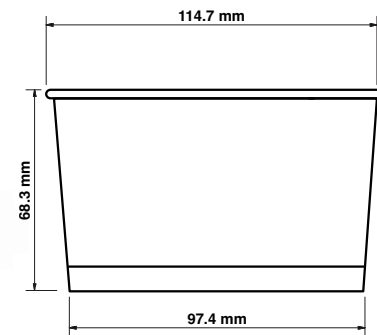

Packaging Configuration

Qty per carton: 1,000	Qty per layer: 6	Lbs per skid: 696
Qty per skid: 24,000	Layer per skid: 4	Box Dimensions: 19.75" x 15.5 x 22.375"
Lbs per carton: 32	Carton per skid: 36	Cubic Feet: 81"

Designs / Item Numbers



White
PFCW16TSQB



16oz Tall Paper Food Container Bulk (No Lid)

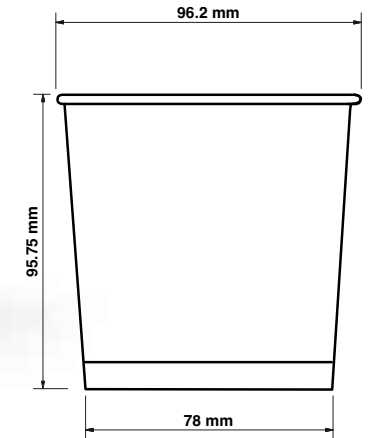

Packaging Configuration

Qty per carton: 1,000	Qty per layer: 6	Lbs per skid: 696
Qty per skid: 24,000	Layer per skid: 4	Box Dimensions: 19.75" x 15.5 x 22.375"
Lbs per carton: 29	Carton per skid: 24	Cubic Feet: 3.96

Designs / Item Numbers



White
PFCW16TB



32oz Paper Food Container

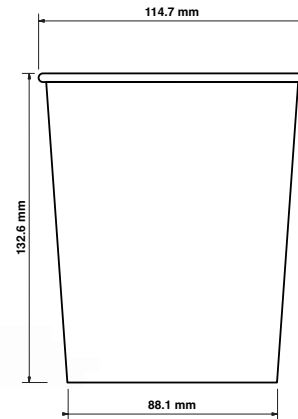

Packaging Configuration

Qty per carton: 500	Qty per layer: 4	Lbs per skid: 470
Qty per skid: 10,000	Layer per skid: 5	Box Dimensions: 23.25" X 9.25" X 17.5"
Lbs per carton: 23.5	Carton per skid: 20	Cubic Feet: 81"

Designs / Item Numbers



White
PFCW32B



Plastic Lids for 8oz - 16oz Tall Paper Food Containers



Packaging Configuration

Qty per carton: 1000	Qty per layer: 12	Lbs per skid: 200
Qty per skid: 20,000	Layer per skid: 4	Box Dimensions: 20" x 8.267" x 22.44"
Lbs per carton: 10	Carton per skid: 20	Cubic Feet: 2.15

Designs / Item Numbers



White
PFCPPL-LID



Paper Vented Lids for 8oz-16oz Tall Paper Food Containers



Packaging Configuration

Qty per carton: 1000	Qty per layer: 4	Lbs per skid: 352
Qty per skid: 16,000	Layer per skid: 4	Box Dimensions: 20" x 16.5" x 27"
Lbs per carton: 22	Carton per skid: 16	Cubic Feet: 5.16

Designs / Item Numbers



White
PFCPL-LID

Paper Vented Lids for 16oz Squat & 32oz Paper Food Containers



Packaging Configuration

Qty per carton: 1000	Qty per layer: 4	Lbs per skid: 256
Qty per skid: 16,000	Layer per skid: 4	Box Dimensions: 20" x 16.5" x 27"
Lbs per carton: 16	Carton per skid: 16	Cubic Feet: 81"

Designs / Item Numbers



White
PFCPL1632-



8oz Paper Food Container Combo w/Paper Vented Lid

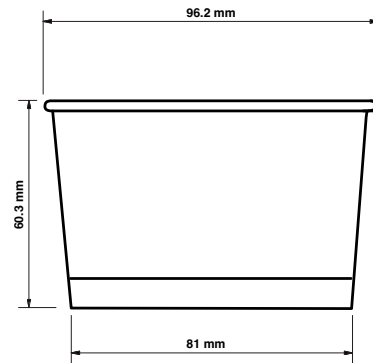

Packaging Configuration

Qty per carton: 250	Qty per layer: 12	Lbs per skid: 450
Qty per skid: 9,000	Layer per skid: 3	Box Dimensions: 19.875" x 8.25" x 25
Lbs per carton: 12.5	Carton per skid: 36	Cubic Feet: 2.37

Designs / Item Numbers



White
PFCWPV08



12oz Paper Food Container Combo w/Paper Vented Lid

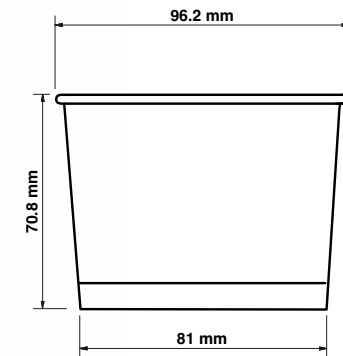

Packaging Configuration

Qty per carton: 250	Qty per layer: 12	Lbs per skid: 468
Qty per skid: 9,000	Layer per skid: 3	Box Dimensions: 19.875" x 8.25" x 25
Lbs per carton: 13	Carton per skid: 36	Cubic Feet: 2.37

Designs / Item Numbers



White
PFCWPV12



16oz Tall Paper Food Container Combo w/Paper Vented Lid

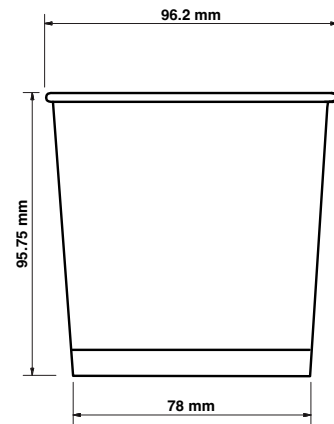

Packaging Configuration

Qty per carton: 250	Qty per layer: 12	Lbs per skid: 486
Qty per skid: 9,000	Layer per skid: 3	Box Dimensions: 19.875" x 8.25" x 25
Lbs per carton: 13.5	Carton per skid: 36	Cubic Feet: 2.37

Designs / Item Numbers



White
PFCWPV16T



16oz Squat Paper Food Container Combo w/Paper Vented Lid

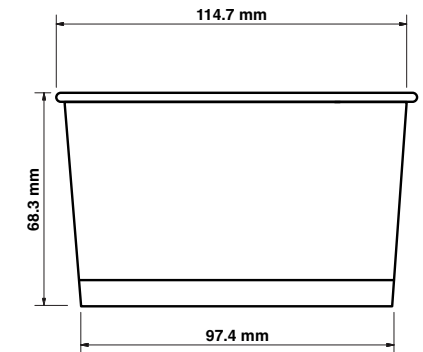

Packaging Configuration

Qty per carton: 250	Qty per layer: 12	Lbs per skid: 486
Qty per skid: 9,000	Layer per skid: 3	Box Dimensions: 19.875" x 8.25" x 25
Lbs per carton: 13.5	Carton per skid: 36	Cubic Feet: 81"

Designs / Item Numbers



White



32oz Paper Food Container Combo w/Paper Vented Lid



Packaging Configuration

Qty per carton: 250	Qty per layer: 4	Lbs per skid: 420
Qty per skid: 5,000	Layer per skid: 5	Box Dimensions: 19.875" x 8.25" x 25"
Lbs per carton: 21	Carton per skid: 20	Cubic Feet: 81"

Designs / Item Numbers



White
PFCWPV32



8oz Paper Food Container Combo w/Plastic PP Vented Lid



Packaging Configuration

Qty per carton: 250	Qty per layer: 15	Lbs per skid: 570
Qty per skid: 15,000	Layer per skid: 4	Box Dimensions: 15.75" x 7.875" x 21.375"
Lbs per carton: 9.5	Carton per skid: 60	Cubic Feet:

Designs / Item Numbers



White
PFCWPL08



12oz Paper Food Container Combo w/Plastic PP Vented Lid

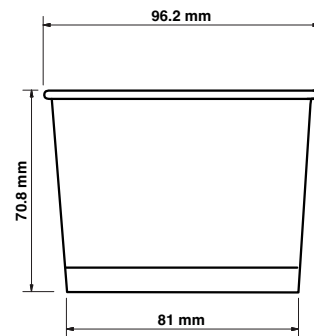

Packaging Configuration

Qty per carton: 250	Qty per layer: 15	Lbs per skid: 600
Qty per skid: 15,000	Layer per skid: 4	Box Dimensions: 15.75" x 7.875" x 21.375"
Lbs per carton: 10	Carton per skid: 60	Cubic Feet:

Designs / Item Numbers



White
PFCWPL12



16oz Tall Paper Food Container Combo w/Plastic PP Vented Lid

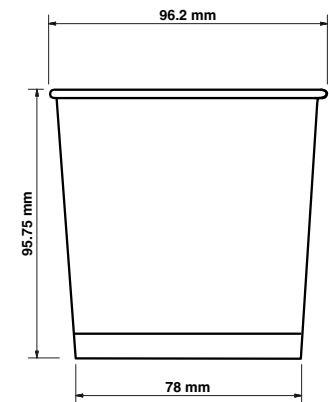

Packaging Configuration

Qty per carton: 250	Qty per layer: 15	Lbs per skid: 690
Qty per skid: 15,000	Layer per skid: 4	Box Dimensions: 15.75" x 7.875" x 21.375"
Lbs per carton: 11.5	Carton per skid: 60	Cubic Feet:

Designs / Item Numbers



White
PFCWPL16T



16oz Squate Paper Food Container Combo w/Plastic PP Vented



Packaging Configuration

Qty per carton: 250	Qty per layer: 15	Lbs per skid: 600
Qty per skid: 15,000	Layer per skid: 4	Box Dimensions: 15.75" x 7.875" x 21.375"
Lbs per carton: 10	Carton per skid: 60	Cubic Feet: 81"

Designs / Item Numbers



White
PFCWPL16SQ



32oz Paper Food Container Combo w/Plastic PP Vented Lid



Packaging Configuration

Qty per carton: 250	Qty per layer: 15	Lbs per skid: 600
Qty per skid: 15,000	Layer per skid: 4	Box Dimensions: 15.75" x 7.875" x 21.375"
Lbs per carton: 10	Carton per skid: 60	Cubic Feet: 81"

Designs / Item Numbers



White
PFCWPL32



9" V-Line Round Paper Plate



Packaging Configuration

Qty per carton: 1000	Qty per layer: 10	Lbs per skid: 570
Qty per skid: 15,000	Layer per skid: 4	Box Dimensions: 17.875" x 9.25" x 17.75"
Lbs per carton: 33	Carton per skid: 40	Cubic Feet:

Item Number RPPVL09

YES PAC

THE ART OF PACKAGING



 260 Centennial Ave
Piscataway, NJ 08854

 201 Industrial Pkwy,
Somerville, NJ

(732) 508-7500
info@yespac.com

www.yespac.com