

PRODUCT GUIDE

Shopping Bag Elements



 **DURO**TM
A NOVOLEX BRAND

BAG



At Duro Bag™, we know a lot goes into creating your brand. A Duro Bag™ Shopping Bag can enhance your brand statement to its fullest potential. Duro® provides all the support you need during the packaging design development, all the way through production and consumer use. You can rely on Duro® for industry leading expertise and quality production capabilities to ensure your brand's creative design is well represented in your packaging.

The Duro Bag™ Brand Advantage

Duro Bag™, a Novolex™ brand, is a premier leader in the paper bag industry with approximately 20 billion paper bags manufactured annually for every market segment from grocery to retail, and convenience to foodservice. You can trust your paper bagging needs to the Duro Bag™ Brand from Novolex™.

Our Mission

Duro Bag™'s mission is to be the preeminent manufacturer of paper bags through uncompromising quality, innovative solutions, customer service and satisfaction, while valuing our employees and vendors with constant attention to our impact on the environment.

Sustainability



A continuous journey of improvement

Novolex is a leader in sustainable paper and plastic flexible packaging with a broad portfolio of solutions focused on source reduction, energy and water conservation, and end of life product planning and management.

Some of the Novolex™ sustainability solutions we bring to our customers include: recycled content plastic and paper products, compostable plastic and paper products, renewable substrates, Novolex's Bag-2-Bag® plastic bag and film recycling program, lower impact substrates such as our EcoCraft® line of paper products, and other industry leading innovations that minimize raw materials while maximizing performance.



Table of Contents

- 4 Retail & Foodservice Overview
- 6 Design Your Bag
- 8-13 Select Your Bag Size
- 14 Select Your Paper
- 15 Select Your Bag Style
- 16 Select Your Handles
- 17 Printing Technique
- 18 Bag Enhancements
- 19 Sustainability Partnerships
- 20 Locations and Brands

For Retail

Enhance the Experience. Create a Memory.

Duro Bag™ empowers customers to maximize branding through high-impact shopping bags. Custom printed bags create the perfect canvas to display your brand and carry your retail marketing strategy long after the sale. Your brand will go places in Duro®'s fashionable, sturdy, and reusable paper shopping bags.

Communicate your presence in the luxury retail world by offering premium retail packaging for your brand. The attention to detail in the materials, printing, and construction conveys you offer the same quality goods inside the bag. Also, a stylish and unique bag can create a connection between your brand and the customer, that will ultimately elevate the consumer experience.



Look for Key Substrate Symbols



100% Recycled Content



40% Recycled Content



FSC® and Rainforest Alliance® Certified Options Available

For Foodservice

Proven Portability. Better Dining Experience.

Duro Bag™ shopping bags were designed with foodservice carryout containers in mind. Duro®'s custom printed bags, showcasing your brand, are more than just a transport vehicle for your gourmet meal. Using this guide, you can build your bag to fit your business – popular to-go containers are listed under each applicable bag.

By designing a stylish, yet functional bag, you improve the customer experience, increase brand exposure and remind customers of their positive culinary delight, even after the meal has been consumed. The quality construction of Duro® foodservice bags offers customers the added value of re-using the bag as they see fit. With a wide variety of styles, colors, materials, and handles, Duro® has an option to carry your brand, and your food, further.



Look for Key Market Segment & Content Symbols



Ideal for Retail Applications



Ideal for Foodservice Applications



Economy Option



Premium Option

Design Your Bag

Mix and Match Features to Bring Out Your Brand

Step 1: Contents and Size

Determine the amount of merchandise you want the bag to carry and what size fits your needs.

WHAT SIZES FIT YOUR NEEDS?



HOW TO MEASURE A BAG

Bag dimensions are listed:
Width x Depth (Gusset) x Height
W x D x H



Step 2: Style

Determine the bag top style best matching your desired look

- Serrated Top
- Ultra Folded Top
- Knotless Macrame Ultra Folded Top
- JV-Slit Top
- 4-Knot Macrame Folded Top

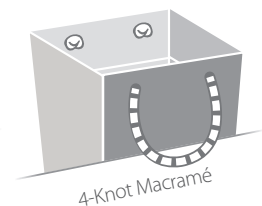
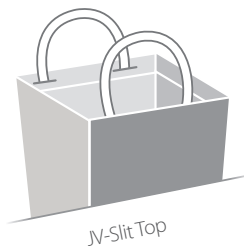
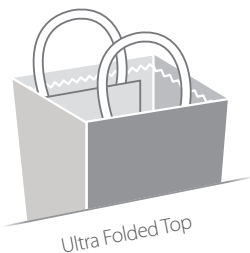

Step 3: Paper Stock

Choose the type of paper stock syncing best with your image.

Virgin Kraft

100% PC Recycled Kraft

100% Recycled Flipside (54% PC)

Virgin White

40% PC Recycled White

100% PC Recycled White

Claycoat

Pro-Smooth

40% PC Recycled Pro-Smooth



Kraft



Flipside



White



Step 4: Printing Technique

Select the printing technique and number of ink colors that are right for your look.

Tail-Print

Pre-Print

Flexography

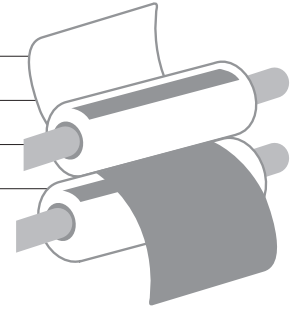

Step 5: Handles

The right handles can transform a bag into an item that has a style all its own.

Paper Twist

Duplex Paper Twist

Soft Core Fabric Cord

Fabric Cord with Paper Core

Filament Polypropylene

Cotton Macramé Rope

Cotton Twill Tape

Grosgrain



Step 6: Bag Enhancements

The extra touch that can add huge impact to your brand.

Varnishes

Hot Stamp

Guillotine Cut

Smooth Bag Front

Extended Length Handles



Step 1: Select Your Bag Size



Gem Mini Shopping Bag

5 1/4" x 3 1/4" x 8 3/8"

Bag Dimensions	Carton Dimensions	Carton Count	Carton Weight	Carton Cube	Cartons Per Pallet	TI/HI
5.25 x 3.25 x 8.38	18 x 11 x 13.5	250	14.2#	1.55	24	8x3

Retail Uses:

- Accessories
- Jewelry
- Cosmetics

Plain Bags in Stock:

White ID# 86841

Kraft ID# 87093

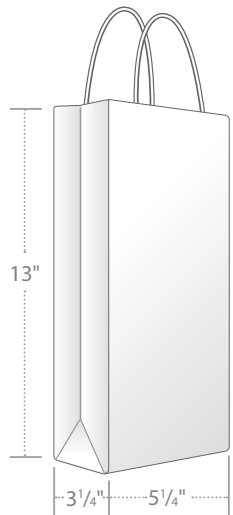

Vino Wine Shopping Bag

5 1/4" x 3 1/4" x 13 1/8"

Bag Dimensions	Carton Dimensions	Carton Count	Carton Weight	Carton Cube	Cartons Per Pallet	TI/HI
5.25 x 3.25 x 13.13	18 x 11 x 13.5	250	17.21#	1.55	24	8x3

Retail Uses:

- Wine gift bags in liquor section
- Wine and liquor bottles at checkout

Foodservice Uses:

- Wine to-go bags
- Wine gift bags

Plain Bags in Stock:

White ID# 81608

Kraft ID# 75079

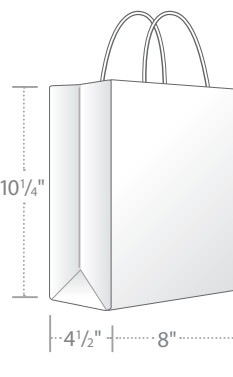

Tempo Small Shopping Bag

8" x 4 1/2" x 10 1/4"

Bag Dimensions	Carton Dimensions	Carton Count	Carton Weight	Carton Cube	Cartons Per Pallet	TI/HI
8 x 4.5 x 10.25	17 X 18.75 X 14.13	250	21.75#	2.61	White: 24 Kraft: 18	White: 6x4 Kraft: 6x3

Retail Uses:

- Accessories
- Jewelry
- Cosmetics

Foodservice Uses:

- Small carryout containers
- Catering
- Individual lunches

Plain Bags in Stock:

White ID# 84598

Kraft ID# 87097

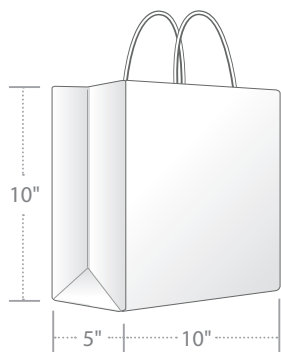

Emerald Intermediate Shopping Bag

10" x 5" x 10"

Bag Dimensions	Carton Dimensions	Carton Count	Carton Weight	Carton Cube	Cartons Per Pallet	TI/HI
10 x 5 x 10	21.75 x 18.5 x 12.5	250	25.43#	2.91	16	4x4

Retail Uses:

- Jewelry
- Shoes - one shoe box

Foodservice Uses:

- Small carryout containers
- Catering
- Bakery items

Non-stock size

Quoted by request



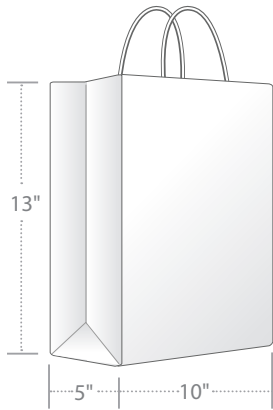

Missy Intermediate Shopping Bag

10" x 5" x 13"

Bag Dimensions	Carton Dimensions	Carton Count	Carton Weight	Carton Cube	Cartons Per Pallet	TI/HI
10 x 5 x 13	21.75 x 18.5 x 13.5	250	26#	3.14	12	4x3

Retail Uses:

- Jewelry
- Small sized goods
- Shoes - one shoe box

Foodservice Uses:

- Small carryout containers
- Catering
- Individual bakery items

Plain Bags in Stock:

White ID# 84641

Kraft ID# 87124

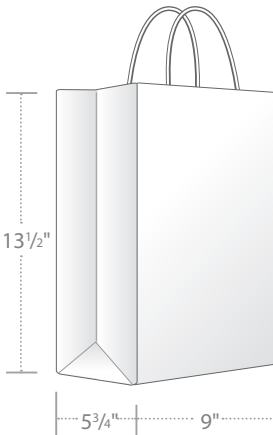

Kary Small Vertical Shopping Bag

9" x 5³/₄" x 13¹/₂"

Bag Dimensions	Carton Dimensions	Carton Count	Carton Weight	Carton Cube	Cartons Per Pallet	TI/HI
9 x 5.75 x 13.5	21.25 x 20.25 x 11	250	27#	2.67	12	4x3

Retail:

- Small sized goods
- Shoes - one shoe box

Foodservice Uses:

- Carryout containers
- Catering
- Individual bakery items

Plain Bags in Stock:

White ID# 84625

Kraft ID# 87098



Bistro Small Foodservice Shopping Bag

10" x 6³/₄" x 12"

Bag Dimensions	Carton Dimensions	Carton Count	Carton Weight	Carton Cube	Cartons Per Pallet	TI/HI
10 x 6.75 x 12	21 x 20 x 10.5	250	27 #	2.55	24	6x4

Retail:

- Bridal / gift shop
- Grocery
- Shoes - one shoe box

Foodservice:

- Small and medium carryout containers
- Catering
- Bakery items

Example Contents:

- (4) 8 x 6 x 2" Takeout Containers

Plain Bags in Stock:

White ID# 88206

Kraft ID# 87490



Characteristic Symbols



Ideal for
Retail Applications



Ideal for Foodservice
Applications

Step 1: Select Your Bag Size

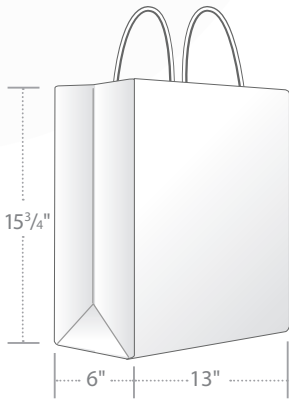

Traveler Medium Shopping Bag

13" x 6" x 15³/₄"

Bag Dimensions	Carton Dimensions	Carton Count	Carton Weight	Carton Cube	Cartons Per Pallet	TI/HI
13 x 6 x 15.75	23.5 x 14.75 x 15.25	250	35#	3.06	18	6x3

Retail Uses:

- Shoes
- Apparel
- Décor
- Toys

Plain Bags in Stock:

- White** ID# 84640
- Kraft** ID# 87127



Jr. Mart Medium Square Shopping Bag

13" x 7" x 13"

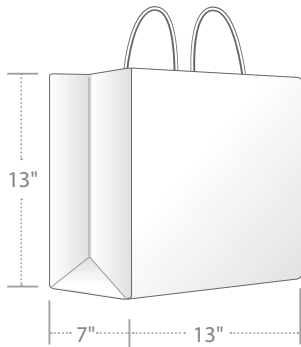

Bag Dimensions	Carton Dimensions	Carton Count	Carton Weight	Carton Cube	Cartons Per Pallet	TI/HI
13 x 7 x 13	20.5 x 15.5 x 16	250	33#	2.94	18	6x3

Retail Uses:

- Shoes

Foodservice Uses:

- Soup containers

Example Contents:

- (3) 4 lb Containers
- (2) 32 oz Containers

Plain Bags in Stock:

- White** ID# 87281
- Kraft** ID# 87523



Tote Medium Horizontal Shopping Bag

16" x 6" x 12"

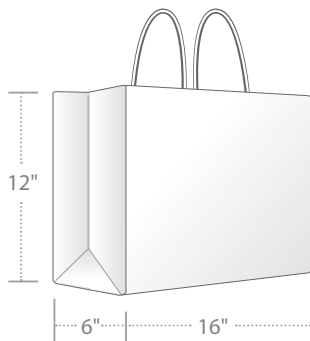

Bag Dimensions	Carton Dimensions	Carton Count	Carton Weight	Carton Cube	Cartons Per Pallet	TI/HI
16 x 6 x 12	23.75 x 16.25 x 15.25	250	36.05#	3.41	15	5x3

Retail Uses:

- Apparel
- Cosmetics

- Shoes - Fits 2 pairs of boots
- Home goods
- Décor

Plain Bags in Stock:

- White** ID# 86785
- Kraft** ID# 87129



Mart Medium Vertical Shopping Bag

13" x 7" x 17"

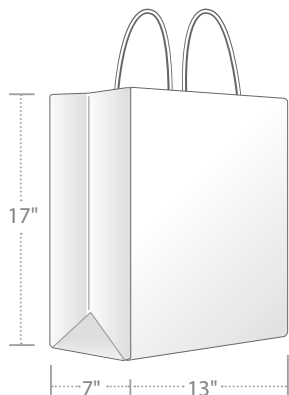

Bag Dimensions	Carton Dimensions	Carton Count	Carton Weight	Carton Cube	Cartons Per Pallet	TI/HI
13 x 7 x 17	23.5 x 15 x 16	250	31#	3.20	18	6x3

Retail Uses:

- Shoes
- Tall Items

- Apparel
- Home goods
- Décor

Foodservice Uses:

- Medium & large carryout containers
- Catering
- Soup containers

Plain Bags in Stock:

- White** ID# 84642
- Kraft** ID# 87128



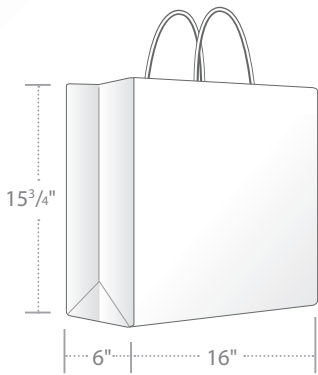

Debonair Medium Square Shopping Bag 16" x 6" x 15³/₄"

Bag Dimensions	Carton Dimensions	Carton Count	Carton Weight	Carton Cube	Cartons Per Pallet	TI/HI
16 x 6 x 15.75	20 x 16.75 x 16	200	41#	3.10	18	6x3

Retail Uses:

- Shoes
- Apparel
- Home goods
- Décor

Plain Bags in Stock:

- **White** ID# 86589
- **Kraft** ID# 87131

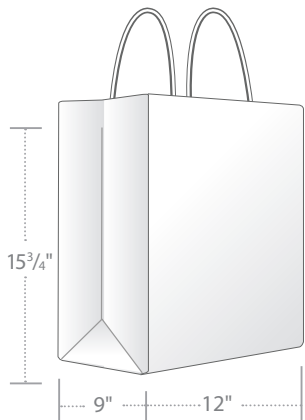

Regal Medium Foodservice Bag 12" x 9" x 15³/₄"

Bag Dimensions	Carton Dimensions	Carton Count	Carton Weight	Carton Cube	Cartons Per Pallet	TI/HI
12 x 9 x 15.75	20.75 x 13 x 16	200	33#	2.49	21	7x3

Foodservice Uses:

- Large and medium carryout containers
- Catering

Example Contents:

- (4) 9 x 9" 3 - Compartment Containers

Plain Bags in Stock:

- **White** ID# 87904
- **Kraft** ID# 87415

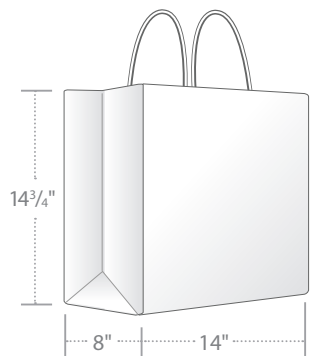

Royal Intermediate Foodservice Bag 14" x 8" x 14³/₄"

Bag Dimensions	Carton Dimensions	Carton Count	Carton Weight	Carton Cube	Cartons Per Pallet	TI/HI
14 x 8 x 14.75	21.5 x 15.5 x 15.5	200	35#	2.98	18	6x3

Foodservice Uses:

- Medium carryout containers
- Catering

Example Contents:

- (4) 8 x 8" 3 - Compartment Containers
- (2) 32 oz Containers & (1) 16 oz Container

Plain Bags in Stock:

- **White** ID# 81646
- **Kraft** ID# 87133



Characteristic Symbols



Ideal for Retail Applications



Ideal for Foodservice Applications

Step 1: Select Your Bag Size



Towner Large Vertical Shopping Bag

16" x 6" x 19³/₄"

Bag Dimensions	Carton Dimensions	Carton Count	Carton Weight	Carton Cube	Cartons Per Pallet	TI/HI
16 x 6 x 19.25	23.75 x 16.25 x 16	200	39#	3.57	15	5x3

Retail Uses:

- Shoes
- Apparel
- Coats
- Bedding
- Home goods
- Décor
- Toys

Plain Bags in Stock:

White ID# 86797

Kraft ID# 87130



Cargo Large Shopping Bag

18" x 7" x 18³/₄"

Bag Dimensions	Carton Dimensions	Carton Count	Carton Weight	Carton Cube	Cartons Per Pallet	TI/HI
18 x 7 x 18.75	23.5 x 18.75 x 15.25	200	36#	3.89	12	4x3

Retail Uses:

- Apparel
- Shoes - Fits 2 pairs of boots
- Home goods
- Décor

Plain Bags in Stock:

White ID# 86787

Kraft ID# 87148

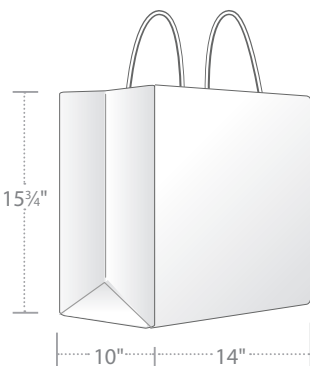

Super Royal Large Foodservice Bag

14" x 10" x 15³/₄"

Bag Dimensions	Carton Dimensions	Carton Count	Carton Weight	Carton Cube	Cartons Per Pallet	TI/HI
14 x 10 x 15.75	23.75 x 16.25 x 16.5	200	41.53#	3.20	18	6x3

Foodservice Uses:

- Large carryout containers
- Catering

Example Contents:

- (4) 9 x 6 x 3" Containers
- (1) 64 oz Container
- (3) 6 x 6 x 3" Containers
- ½ Steamtable Pan

Plain Bags in Stock:

White ID# 85934

Kraft ID# 87145



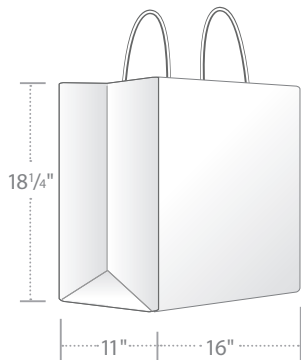

Grande Extra Large Foodservice Bag

16" x 11" x 18 1/4"

Bag Dimensions	Carton Dimensions	Carton Count	Carton Weight	Carton Cube	Cartons Per Pallet	TI/HI
16 x 11 x 18.25	24 x 7.25 x 18.75	200	60#	3.51	15	5x3

Foodservice Uses:

- Large carryout containers
- Catering
- 10 1/2" pizza boxes

Example Contents:

- 1/2 Steamtable Pan
- Bedding
- (1) Half Sheet Cake Container
- (6) 4lb Food Containers

Plain Bags in Stock:

White ID# 87942

Kraft ID# 87941

(Virgin Paper only)

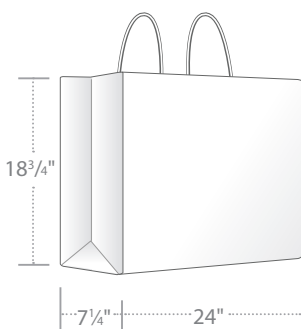

Magnum Extra Large Shopping Bag

24" x 7 1/4" x 18 3/4"

Bag Dimensions	Carton Dimensions	Carton Count	Carton Weight	Carton Cube	Cartons Per Pallet	TI/HI
24 x 7.25 x 18.75	23.75 x 16.25 x 15.75	125	47#	3.40	8	2x4

Retail Uses:

- Shoes
- Apparel
- Coats
- Home goods
- Décor
- Toys

Foodservice Uses:

- Catering

Plain Bags in Stock:

White ID# 81289

Kraft ID# 80722

(Virgin Paper only)



Stock Bag Sizes Measured Length x Width x Height

Gem	5 1/4" x 3 1/4" x 8 3/8"	Tote	16" x 6" x 12"	Towner	16" x 6" x 19 1/4"
Vino	5 1/4" x 3 1/4" x 13"	Traveler	13" x 6" x 15 3/4"	Super Royal	14" x 10" x 15 3/4"
Tempo	8" x 4 1/2" x 10 1/4"	Debonair	16" x 6" x 15 3/4"	Cargo	18" x 7" x 18 3/4"
Missy	10" x 5" x 13"	Mart	13" x 7" x 17"	Grandé	16" x 11" x 18 1/4"
Kary	9" x 5 3/4" x 13 1/2"	Royal	14" x 8" x 14 3/8"	Magnum	24" x 7 1/4" x 18 3/4"
Bistro	10" x 6 3/4" x 12"	Regal	12" x 9" x 15 3/4"		

Characteristic Symbols



Ideal for Retail Applications



Ideal for Foodservice Applications

Step 2: Select Your Bag Style

Determine the bag top style best matching your desired look.

Continue to evoke your brand image from the time the contents are placed inside the bag to the moment customer unloads the bag at home.

Duro Bag™ creates a bag style that is a reflection of your brand image – clean and crisp or a little rough around the edges, we have an option for you.



Serrated Top Automatic Handle

- Serrated Top
- Handle is automatically formed and glued to the bag with a paper handle patch while on the bag machine



Custom Serrated Top Hand-Inserted Handle

- Custom Serrated Top
- Handle is hand inserted and glued to the bag with paper/board handle patch



Ultra 1/2" Folded Top

- Hand Folded 1/2" Top Fold
- Attractive smooth top look
- Handle and patch are attached by hand just below the top fold edge

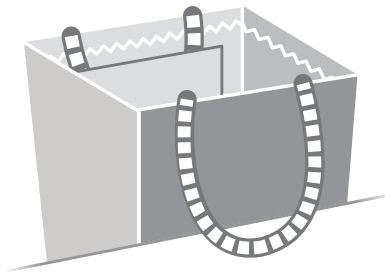

Knotless Macramé Ultra 1/2" Folded Top

- Hand Folded 1/2" Top Fold
- Attractive smooth top look
- Handle and patch are attached by hand just below the top fold edge



JV-Slit 2 1/4" Folded Top

- Hand Folded 2 1/4" Top Fold
- Handle is inserted through JV-Slit and glued inside top fold
- Top fold covers inside handle patch and accommodates graphic printing

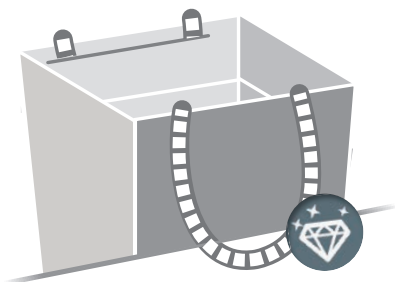

Knotless Macramé JV-Slit

- Handle is inserted through JV-Slit and glued inside top fold
- Hand Folded 2 1/4" Top Fold
- Compact style allows for reduced carton cube

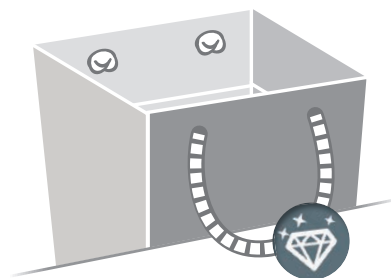



























4-Knot Macramé

- Hand Folded 1 1/2" Top Fold
- Hand-inserted 1 1/2" cardboard reinforcement strip
- Handle holes are punched in the top fold 2 1/2"-4 1/2" apart
- Handle material is precut to 15 1/4" and is fed through the holes and hand-tied with 4 knots inside the bag

Step 3: Select Your Paper

Choose the type of paper stock syncing best with your image.

Ranging from the Eco-conscious Natural Brown Kraft to a durable Claycoat, Duro Bag™'s materials will match the demands of what goes inside the bag. Duro Bag™ provides a range of substrates to compliment your brand image, from our stock products collection or a one of a kind custom print.

	Paper Type	Key Features	Characteristics
	Virgin Kraft	<ul style="list-style-type: none"> Natural look Durable standard basis weight 60#-70# 	
	100% PC Recycled Kraft	<ul style="list-style-type: none"> 100% Post Consumer Recycled Content Certified Options Available Environmentally friendly natural look Standard basis weight 60# 	   
	100% Recycled Flipside	<ul style="list-style-type: none"> 100% Recycled Content, 54% Post Consumer Unique 2-sided paper, 1 side white, 1 side tan Printing available on either side Ideal for printing solid and design graphics 	   
	Virgin White	<ul style="list-style-type: none"> Upgraded look Smoother printing surface than Kraft Durable standard basis weight 60#-70# 	
	40% PC Recycled White	<ul style="list-style-type: none"> Upgraded look Smoother printing surface than Kraft Durable standard basis weight 60#-70# 	  
	100% PC Recycled White	<ul style="list-style-type: none"> 100% Recycled Content Smoother printing surface than Kraft Durable standard basis weight 60#-70# 	  
	Pro-Smooth	<ul style="list-style-type: none"> Exceptional print quality Supports high resolution 4 color process printing Smoother than average paper types Excellent photographic reproduction 	
	40% PC Recycled Pro-Smooth	<ul style="list-style-type: none"> Exceptional print quality Supports high resolution 4 color process printing Smoother than average paper types Excellent photographic reproduction 	
	Claycoat	<ul style="list-style-type: none"> Claycoated HiGlo Coated 1 Side Paper Very smooth surface prints images clearly Virtually no ink absorption yields vibrant colors Durable standard basis weight 70# 	

Characteristic Symbols



Step 4: Select Your Handle

Transform a bag into an item that has a value all its own.

Duro Bag™ provides multiple options to enhance the look of your bag selection - a handle to compliment the look and feel of your brand. Constructed of quality materials, Duro Bag™ has created a selection of visually appealing and functional handles to choose from.

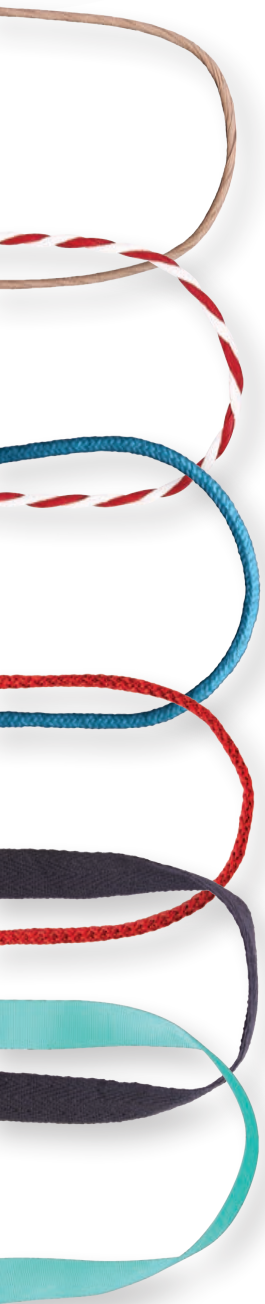

Handle Type	Key Features	Characteristics
Stock Color Paper Twist	<ul style="list-style-type: none"> Standard Kraft Color 29 Stock Colors (shown below) 	
Dyed to Match Color Paper Twist	<ul style="list-style-type: none"> Upgraded cohesive look 	
Dyed to Match Duplex Paper Twist	<ul style="list-style-type: none"> Eye-catching design grabs visual interest Two colors twisted together make the duplex handle Stock or dyed to match colors can be used 	
Dyed to Match Fabric Cord with Soft Core	<ul style="list-style-type: none"> Filament Polypropylene soft core fabric cord 	
White Fabric Cord with Paper Core	<ul style="list-style-type: none"> White acrylic fabric cord handle with paper core Upgraded look and comfort 	
Dyed to Match Fabric Cord with Paper Core	<ul style="list-style-type: none"> Cotton fabric cord handle with paper twist core Upgraded look and comfort from paper twist 	
Dyed to Match Filament Polypropylene	<ul style="list-style-type: none"> Matching handle color increases brand consistency 	
Dyed to Match Cotton Macramé Rope	<ul style="list-style-type: none"> Matching handle color increases brand consistency Natural look and feel 	
Cotton Twill Tape	<ul style="list-style-type: none"> Cotton twill enhances perceived bag quality Comfortable to carry Natural look and feel 	
Grosgrain	<ul style="list-style-type: none"> Polyester grosgrain enhances perceived bag quality Showcases "gift bag" appearance Comfortable to carry 	

Paper Twist Handle Stock Color* Options:

(*Colors shown are approximate, please request a sample for exact color matching)



Step 5: Printing & Graphic Options

Transform a bag into an item that has an advantage all its own.

With custom print available, options are virtually limitless. If you want a picture of the sky, you got it. If you want a bag to compliment your newest store display and signage, you can provide the idea and we will provide the solution. Create a bag that is fun to carry - for now and the future.

Graphics	Key Features	Characteristics
Tail-Print:	<ul style="list-style-type: none"> In Line roll-to-bag printing Most economical way to get branded bags Up to 4 colors Line art/moderate detail Loose to moderate registration 	
Pre-Print:	<ul style="list-style-type: none"> Offline roll-to-roll printing Up to 8 colors High Registration Fine detail, screens, half tones Special coating/varnishes, including UV 	
Flexography:	<ul style="list-style-type: none"> Flexographic 4 color process printing Medium resolution up to 133 line screen Raised printing surface Moderate grade paper stocks 	

(Varnish is considered a color/print station)

Graphics	Key Features	Characteristics
Line Art	<ul style="list-style-type: none"> Most cost-effective graphics application Can be tail-printed for quicker turnaround More economical pre-press than 4 color process 	
Duo Tone/ Half Tone	<ul style="list-style-type: none"> Upgraded bag imagery High color clarity, detail and resolution Black and white photographic reproduction 	
4-Color Process	<ul style="list-style-type: none"> High Definition Resolution up to 150 line screen Offset look with Flexo printing Extremely high color clarity Soft photographic reproduction Excellent flesh tones Highlights mid-tones and mass-tones 	
High Definition	<ul style="list-style-type: none"> Available in 4-Color Process, Duo Tone and Tri-Tone Resolution between 150-200 line screen Offset look with Flexo printing Extremely high color clarity Soft photographic reproduction 	
Insider	<ul style="list-style-type: none"> Simultaneous inside/outside printing Up to 3 print stations per side Registered print position inside and out 	



Line Art



Duo Tone



4-Color Process



High Definition



Insider

Step 6: Enhance Your Bag

The little touches can add huge value to your brand.

Add just a little something extra special to your Duro Bag™ with this list of enhancements. From the way the bag feels to the way it looks, every detail is important because it is essential to your brand. Create a one of a kind combination that is sure to leave a lasting impression with your customers.

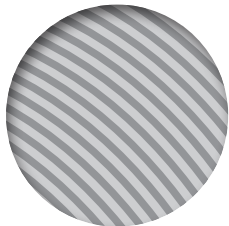

Standard Bag Front

Smooth Bag Front



Enhancement	Key Features	Characteristics
Mirage Stripe	<ul style="list-style-type: none"> Economical way to upgrade branding Tinted varnish printed in vertical stripe pattern Creates the illusion of an embossed pattern 	
Gloss Varnish	<ul style="list-style-type: none"> Overprinted on claycoat, makes colors appear more rich Lower environmental impact than lamination 	
Matte Varnish	<ul style="list-style-type: none"> Satin finish masks over the inherent gloss ink characteristics Prevents ink rub-off by sealing printed surface 	
Gloss UV	<ul style="list-style-type: none"> Extremely high gloss finish Available on all substrates and can be applied while printing Resembles lamination with lower environmental impact 	
Wet Look Gloss UV	<ul style="list-style-type: none"> Same benefits of Gloss UV with added gloss "wet" look Enhances bag artwork and brightens ink colors Wet Look stems from printing UV on uncoated papers 	
Soft Touch	<ul style="list-style-type: none"> Gives silky smooth satin finish Lower environmental impact than lamination 	
Smooth Bag Front	<ul style="list-style-type: none"> Smooths bag front for optimum sleek appeal 	
Guillotine Cut	<ul style="list-style-type: none"> Straight edge cut on top fold and on bottom of bag creates a clean look 	
Extended Length Handles	<ul style="list-style-type: none"> Extends the length of bag handles Macramé extended length handles gives option for shopper to carry on shoulder 	
Conventional Hot Stamp	<ul style="list-style-type: none"> Eye-catching metallic look Higher perceived bag quality 	

Characteristic Symbols



Sustainability Partnerships

Novolex™ is committed to the protection of the earth through recycling and promotion of sustainable products. We are proud to hold certificates for the following organizations:



Forest Stewardship Council®

The FSC® promotes environmentally appropriate, socially beneficial, and economically viable management of the world's forests. The unique role of the FSC® is to bring together people, organizations and businesses to develop consensus-based solutions that promote responsible stewardship of the world's forests. Duro Bag™ uses the FSC® Trademark License C010800 for certified chain of custody products made at all Duro plants.



The mark of responsible forestry



Rainforest Alliance®

The Rainforest Alliance® is an international nonprofit conservation organization that certifies forestry and agricultural operations, ensuring that they meet rigorous standards for the conservation of natural resources and the rights and welfare of workers and local communities. Working with the Rainforest Alliance®, Novolex has earned FSC® Chain of Custody certification for its Duro Bag lines of 100% post-consumer recycled bags. The FSC® certified paper used for the manufacturing of these bags can be tracked through the supply chain including collection from the end user, sorting, paper making, transport, bag making and shipment of the finished product.



How2Recycle

Novolex™ is proud to support organizations like the Sustainable Packaging Coalition (SPC) that promote industry wide sustainability initiatives such as How2Recycle the next generation of standardized recycling symbols. We are proud to work with our customers and the SPC to get the right markings on your products. Learn more at: **How2Recycle.info**

Locations and Brands



Sustainability: A continuous journey of improvement

Novolex is a leader in sustainable paper and plastic flexible packaging with a broad portfolio of solutions focused on source reduction, energy and water conservation, and end of life product planning and management.

Some of the Novolex™ sustainability solutions we bring to our customers include: recycled content plastic and paper products, compostable plastic and paper products, renewable substrates, Novolex's Bag-2-Bag® plastic bag and film recycling program, lower impact substrates such as our EcoCraft® line of paper products, and other industry leading innovations that minimize raw materials while maximizing performance.



©July 2016 Novolex™. Learn more about the Novolex™ family of brands at novolex.com. Novolex™ is a member of the Sustainable Packaging Coalition.



www.novolex.com | 101 E Carolina Avenue | Hartsville, SC 29550 | 800-845-6051

D_CA_0030_0716